

# Halo 85cm Satellite Dish



***SATAUTOA85P***

## **User Manual**

UEC 85cm Automatic Deploy Satellite Dish  
With Quad-Output LNB, Skew And GPS.

# Contents

---

---

<b>1. Installation.....</b>	<b>3</b>
1.1 Inspect Parts and Get Tools.....	4
1.2 Wiring Connection.....	6
1.3 Select Location for Installation.....	7
1.4 How to install ODU.....	8
1.5 How to assemble dish.....	10
1.6 How to install cable gland entry.....	11
1.7 How to install dish absorber.....	12
1.8 How to install IDU.....	13
1.8.1 How to install IDU touch panel.....	14
1.8.2 How to install IDU power box.....	15
<b>2. Operation.....</b>	<b>16</b>
2.1 Change Target Satellite.....	17
2.2 Set Triple Satellite Pairs.....	18
2.3 Set LNB Information.....	21
2.4 Set GPS Information.....	24
2.5 Edit Satellite Information.....	27
2.6 Set To Default Settings.....	35
2.7 Monitor and Diagnostic.....	37
2.7.1 Manual control mode.....	39
2.7.2 Self-diagnosis.....	40

# 1. Installation

---

---

This guide explains how to install and operate the RV satellite TVRO antenna system

- Before you install the antenna, please read each of the procedures in the installation guide carefully and understood the safety warning information.
- 



This icon indicates that you must pay your attention to it.

# 1.1 Inspect Parts and Get Tools

Unpack the box carefully and examine all of the supplied parts to ensure nothing was damaged in shipment

The following items are included in the box, Ensure all components are included before proceeding the installation

## Components bundle

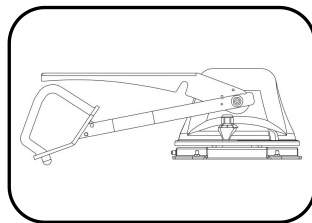

**ODU**

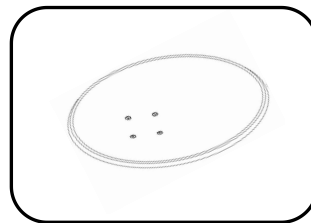

**Dish**

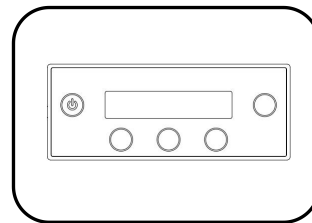

**IDU Touch Panel**

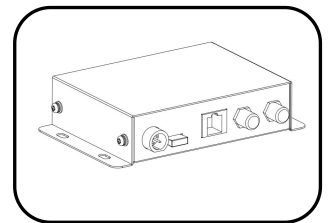

**IDU Power Box**



**To Receiver Cable  
(1M)**



**IDU to ODU Cable  
(8M)**

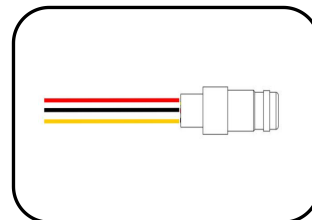

**Power Cable  
(1M)**

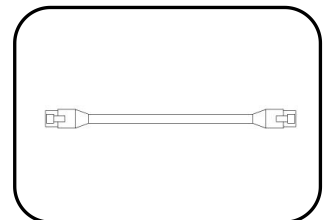

**Ethernet Cable  
(1M)**

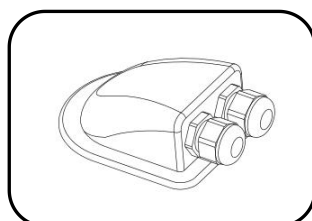

**Cable gland Entry**

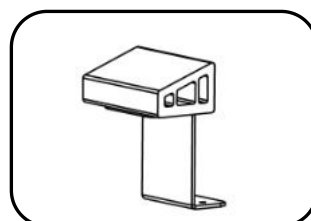

**Dish Absorber**

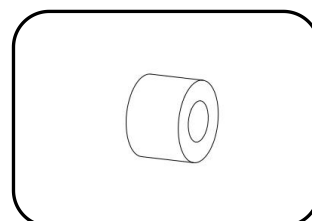

**Shore (4)**

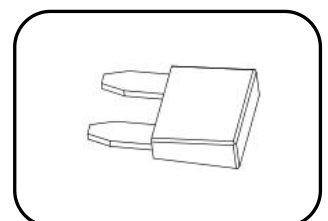

**Fuse (Spare Part)**

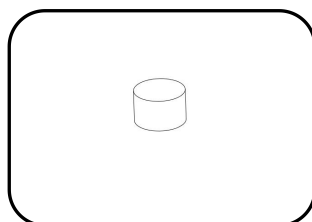

**Button Sponge (5)**

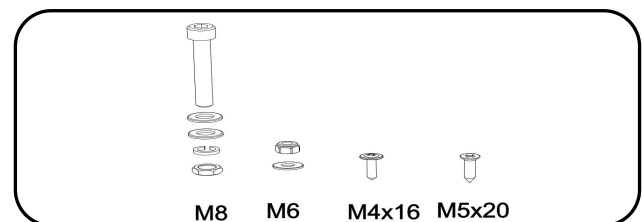

**Screw**  
**M8(4) M6(4) M4X16(8) M5X20(2)**



**User Manual**

# 1.1 Inspect Parts and Get Tools

---

---

 Gather all the tools

---

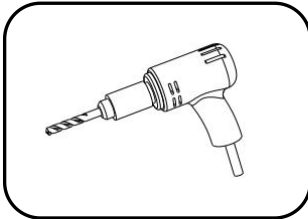

**Power Drill**

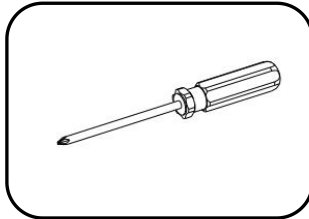

**Cross-Head  
Screwdriver**

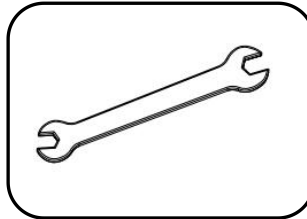

**11mm and  
13mm Spanner**

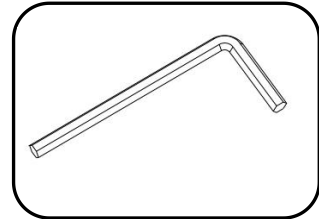

**6mm Allen Wrench**

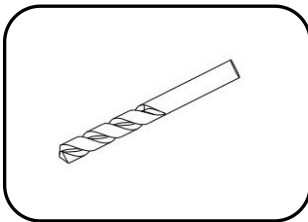

**4mm, 10mm, 20mm  
Bits**

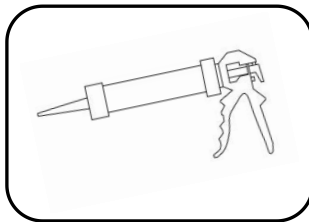

**Silicon Sealant**

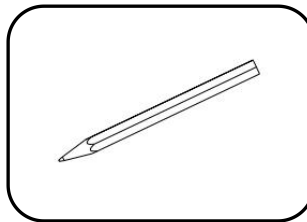

**Pencil**

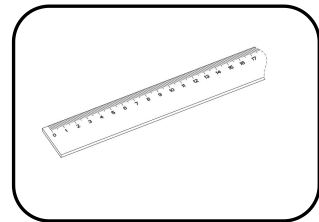

**Ruler**

# 1.2 Wiring Connection

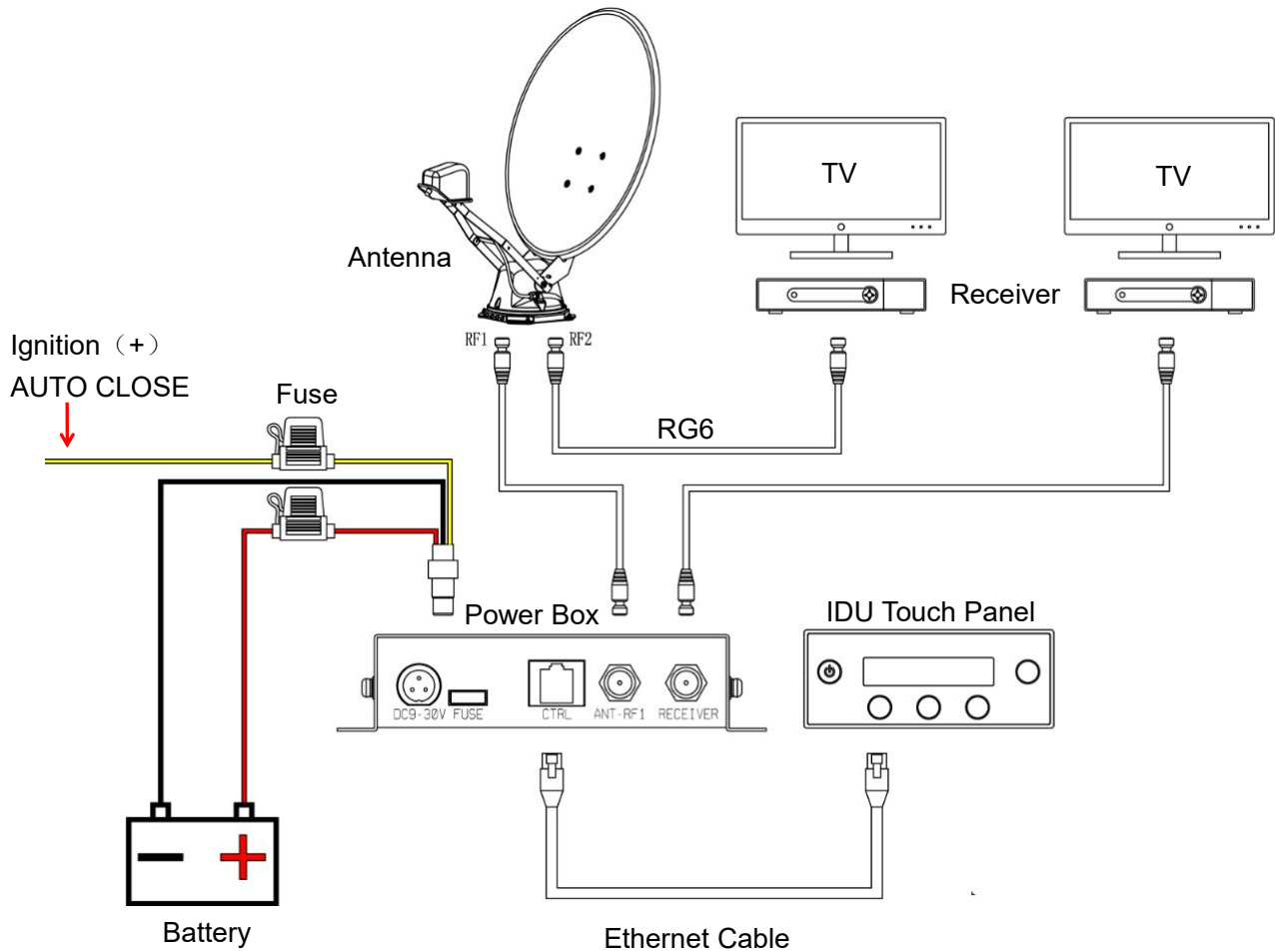

# 1.3 Select Location for Installation

---

---

## Selecting the ODU location

Pick an area on the roof of your mobile home that will allow the ODU to be mounted as flat and level and strong as possible

With good support that will permit the dish, once fitted and raised, to have a full 360 degree rotation and elevation range.

The ODU requires a clear view of the sky to receive satellite TV, The horizon at all the directions to avoid blockage of the satellite signal.

---

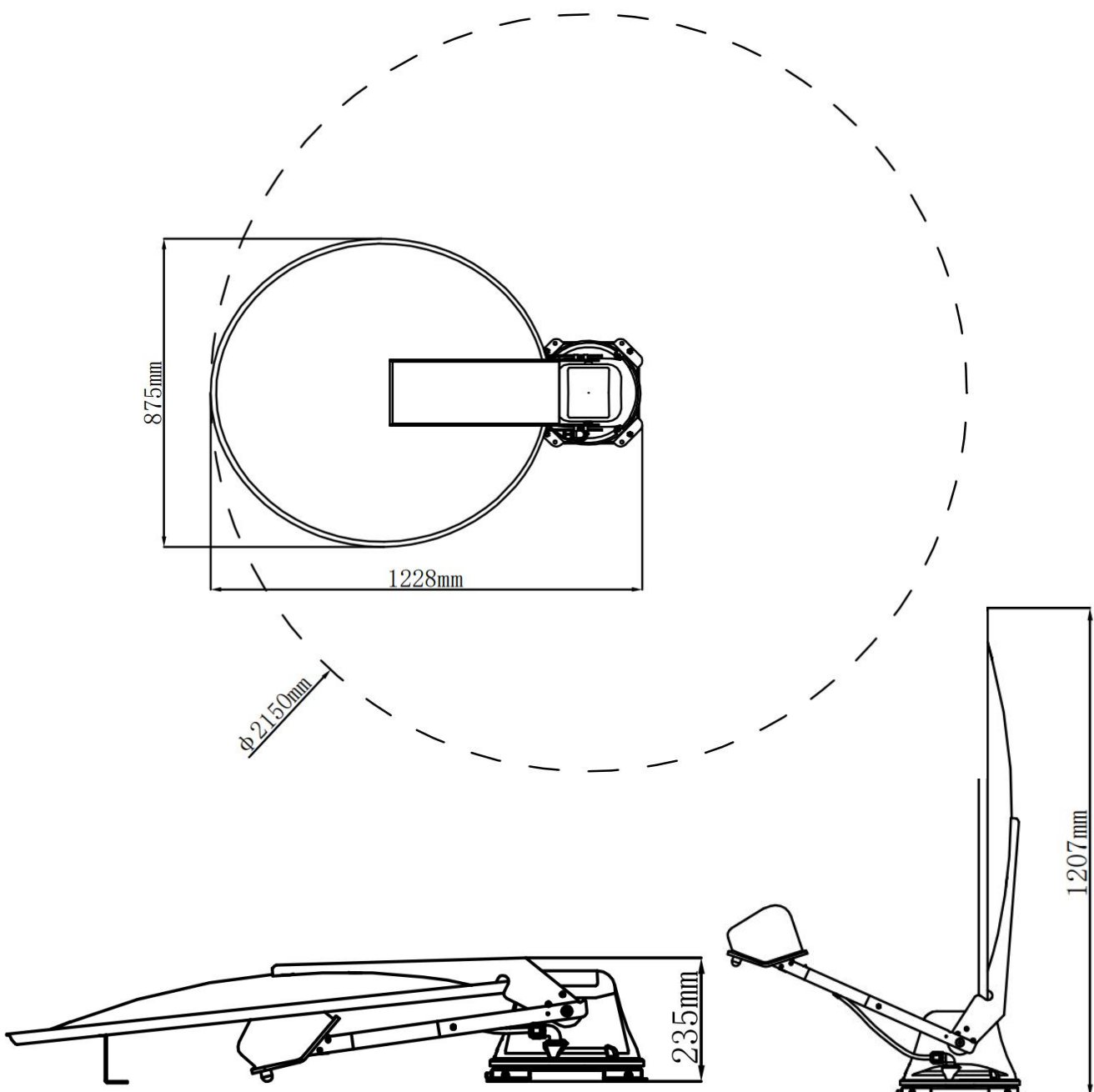

# 1.4 How to install ODU

## Required parts for assembly

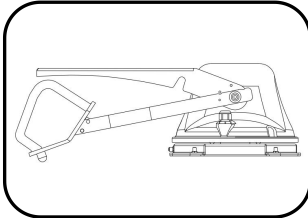

**ODU**

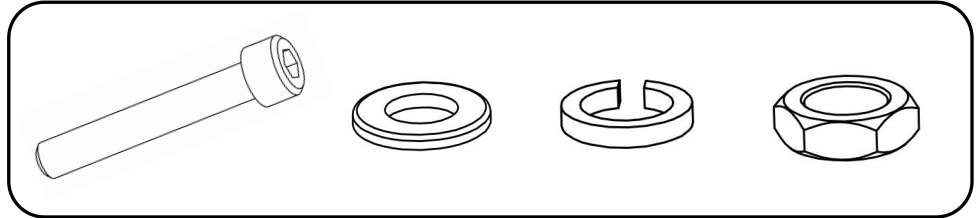

**Screw M8(4) Flat Washer(8) Spring Washer(4) Hex. Nut(4)**

**1**

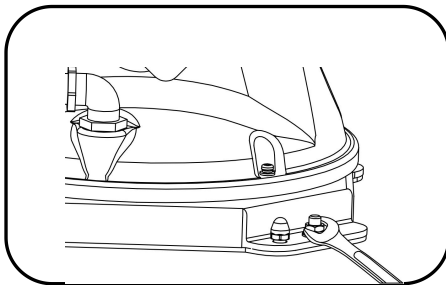

Loosen nuts and remove nuts and washers(8 pcs) on the main unit

**2**

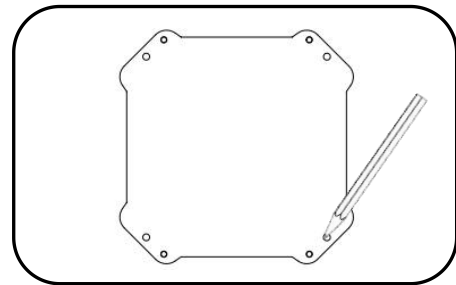

Take out the base plate.Keep the main unit and parts aside for re-assembly after mounting plate

**3**

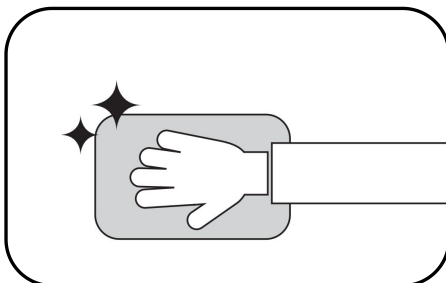

Clean the surface with cleaner

**4**

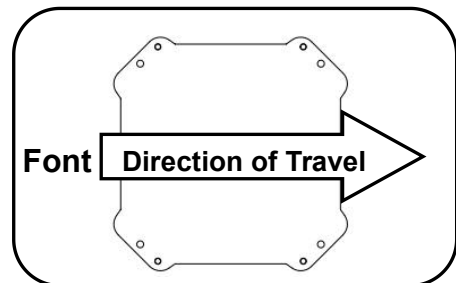

Locate mounting plate in the centre of the vehicle roof

**5**

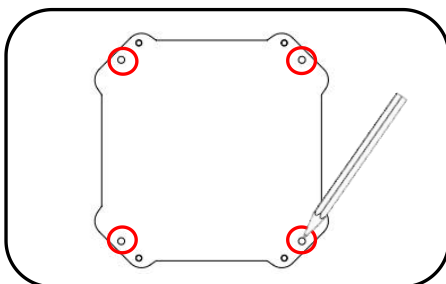

Mark 4 holes with pencil

**6**

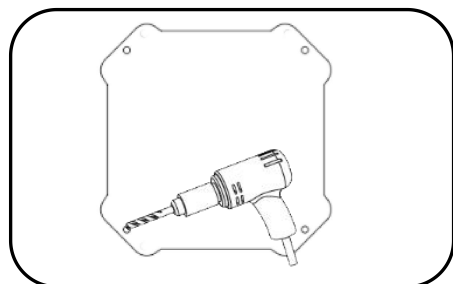

Make 4 holes with a power drill



# 1.4 How to install ODU

---

---

7

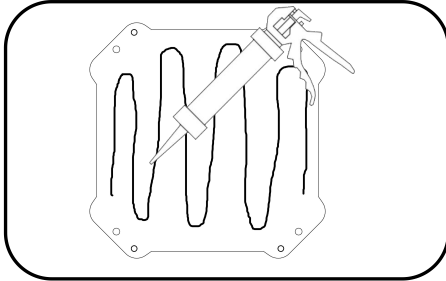

Apply silicon sealant on the mounting plate and leave 2cm inward gap from the line

8

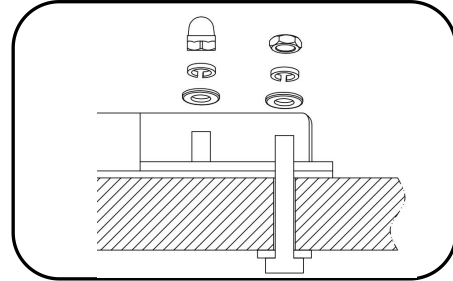

Re-assembly the main unit to the base plate

9

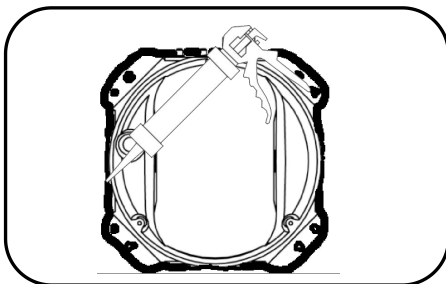

Apply silicon sealant around the ODU base, include the screw

# 1.5 How to assemble dish

## Required parts for assembly

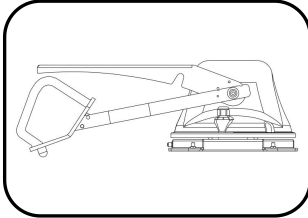

**ODU**

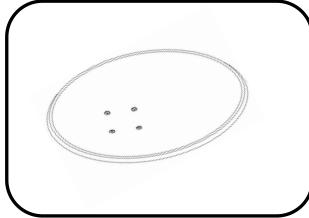

**Dish**

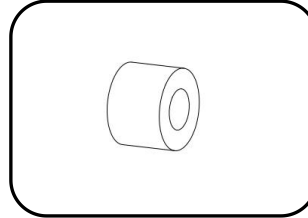

**Shore (4)**

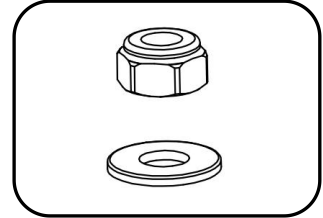

**M6(4)**

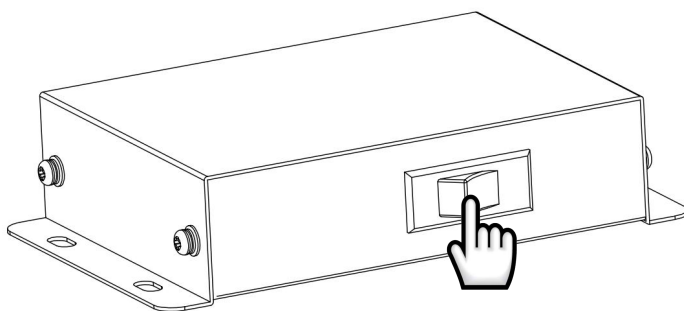
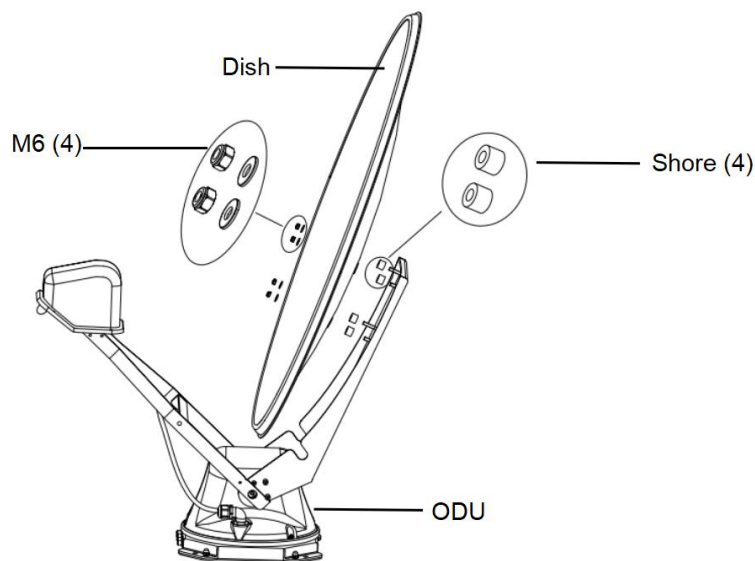

1. Press **POWER** button on IDU power box to turn on the unit. The dish bracket will lift up after power-on and the close.

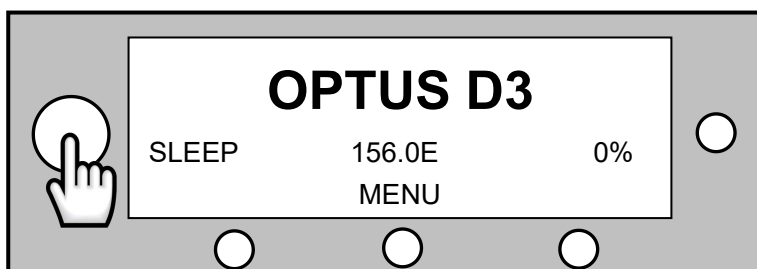

2. Press **POWER** button of IDU touch panel. When dish bracket is lifted up to vertical direction (about 90 degrees), turn the unit off.

# 1.6 How to install cable gland entry

## Required parts for assembly



To Receiver Cable (1M)



IDU to ODU Cable (8M)

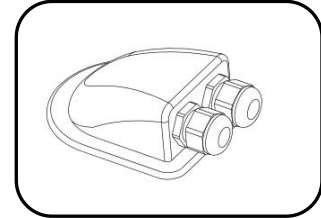

Cable gland Entry

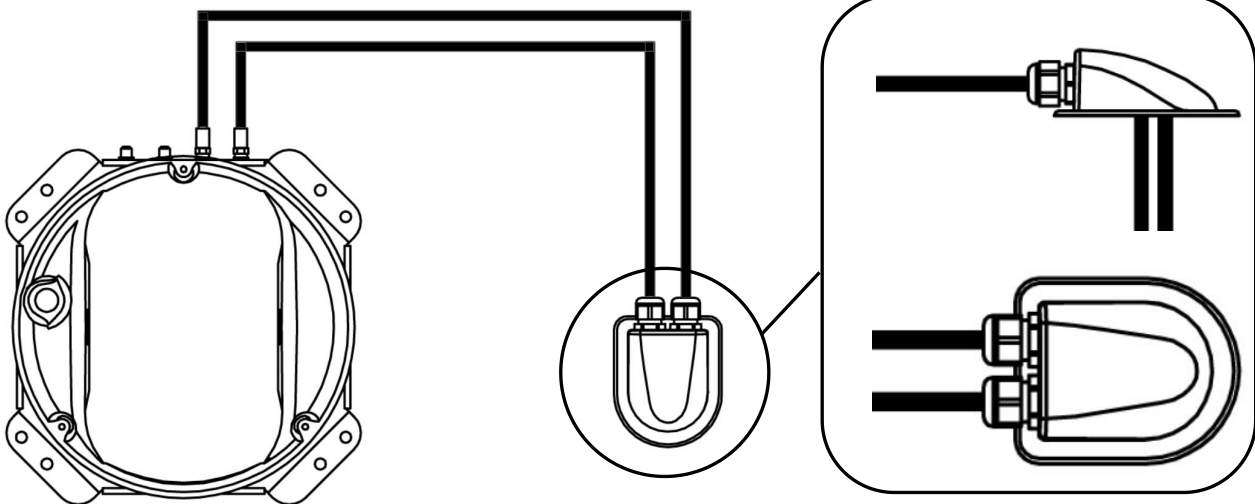

**1**

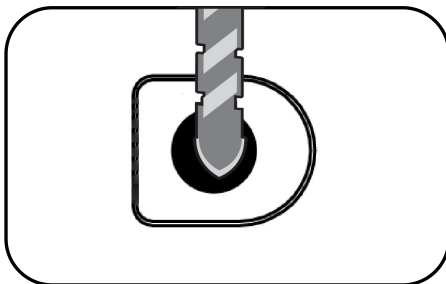

Drill a 25mm hole (or larger) in the centre

**2**

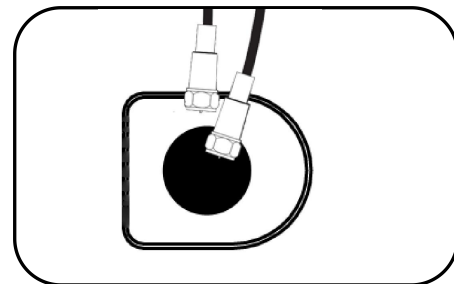

Make sure that hole size is big enough to insert all cables together by one and one

**3**

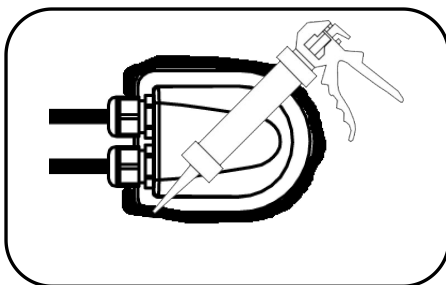

Apply Silicon Sealant around cable Gland Entry

# 1.7 How to install dish absorber

Required parts for assembly

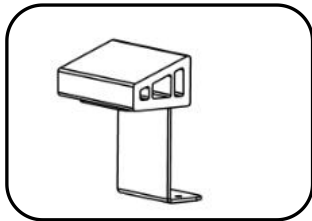

Dish Absorber

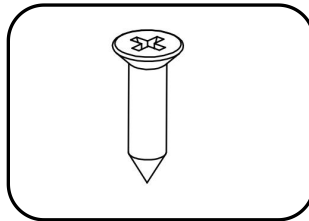

Screw (M5)

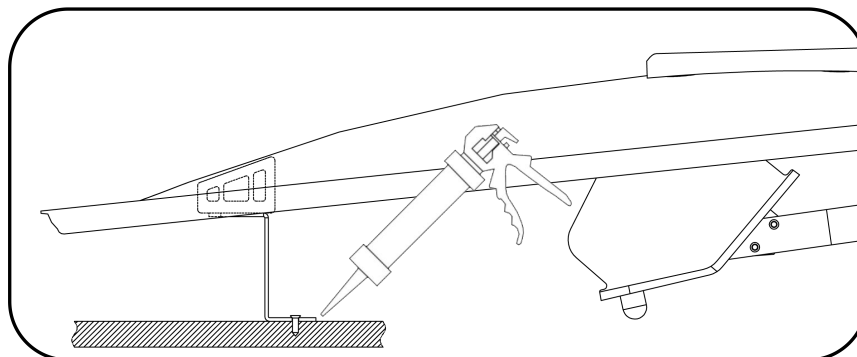
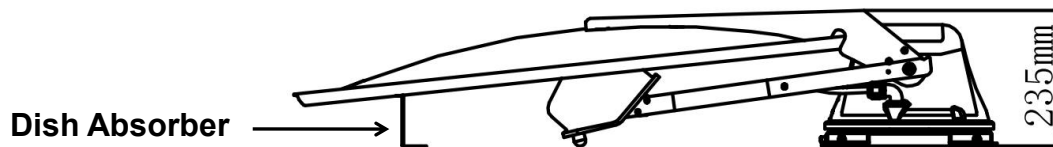

1. Attach dish absorber to the dish
2. Fix the dish absorber with M5X20 screw
3. Apply Silicon Sealant around

# 1.8 How to install IDU

## Required parts for installation

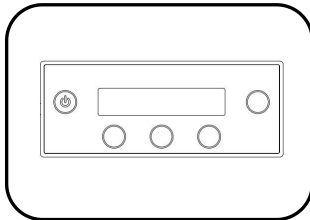

IDU Touch Panel

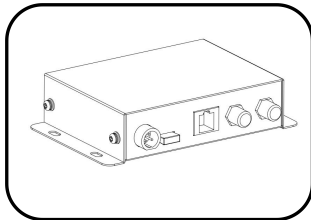

IDU Power Box

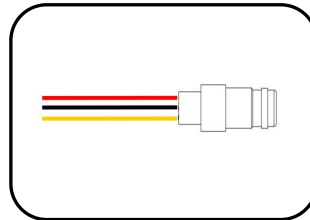

Power Cable (1M)

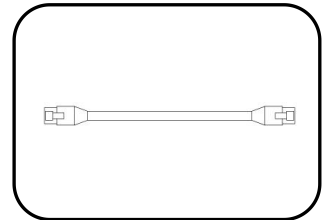

Ethernet Cable (1M)

## Power Cable Connection

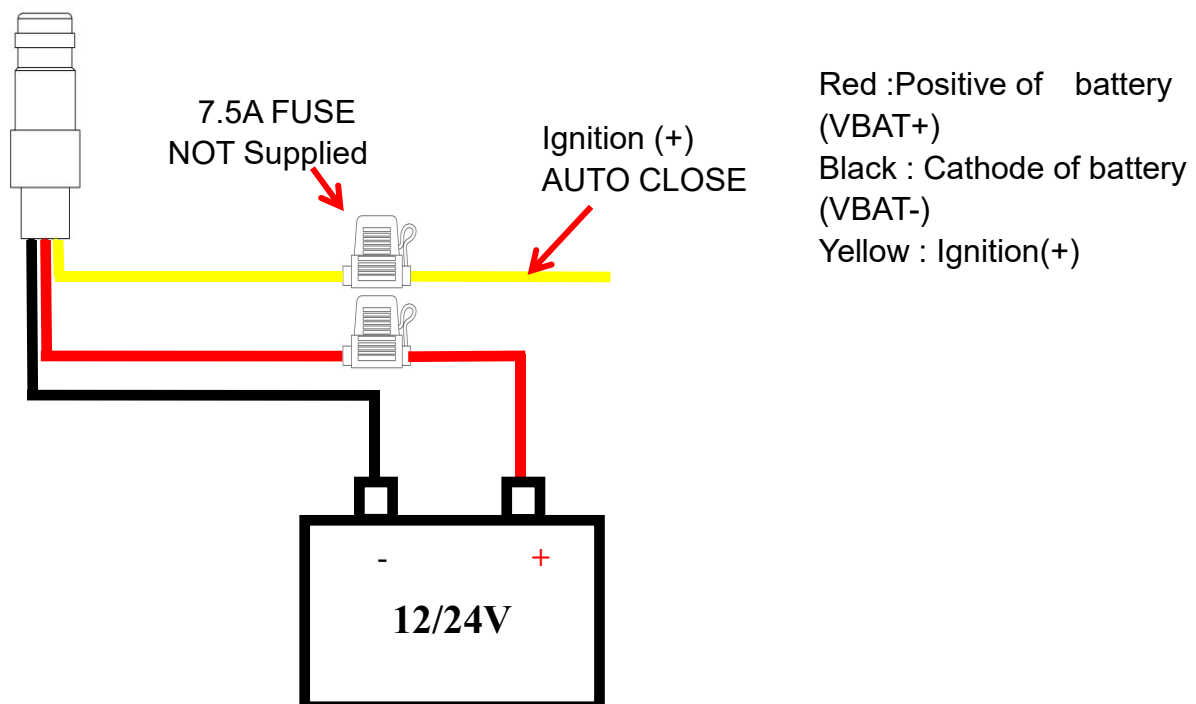

# 1.8.1 How to install IDU touch panel

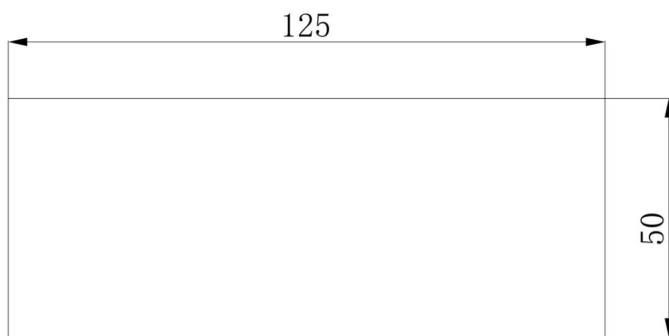

**1.** Locate a suitable location for the IDU Touch Panel.

Flush Mount - Mark out with a pencil and mark a hole 125mm by 50mm. Carefully cut on the hole so panel can be mounted.



**Please check there is nothing behind where you are cutting.**

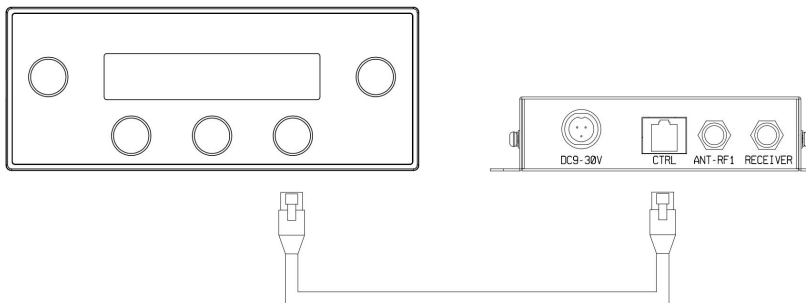

**2.** Carefully connect the Cable between IDU Remote Panel and The length of RJ45 ethernet cable you use should be within 8 meters.

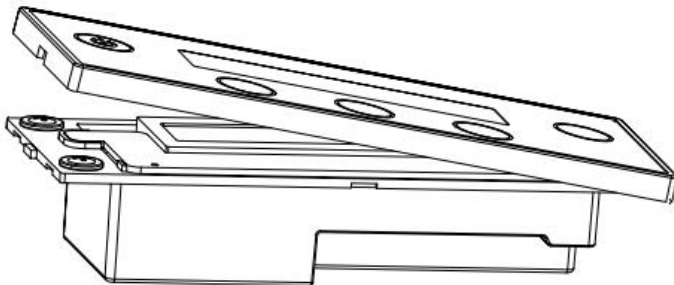

**3.** The IDU Touch Panel is required to be opened to access the four mounting screw holes. Carefully open the top of the panel.

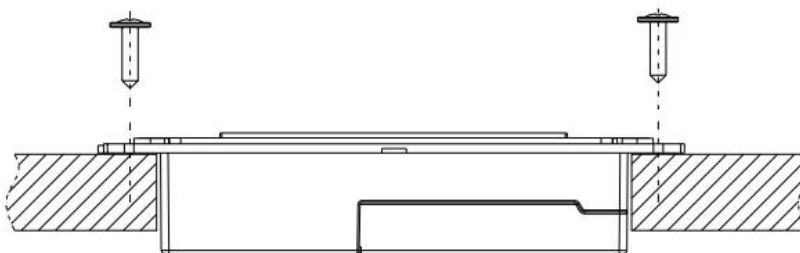

**4.** Use the four screws provided to securely mount the IDU to the wall

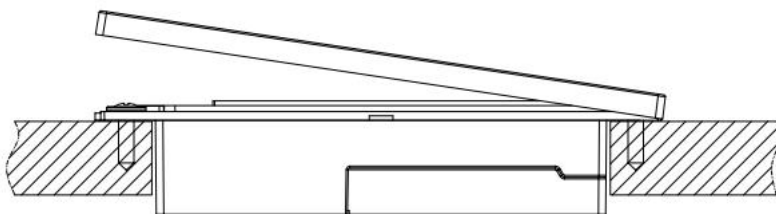

**5.** Carefully refit the Touch panel to the IDU

## 1.8.2 How to install IDU power box

---

---

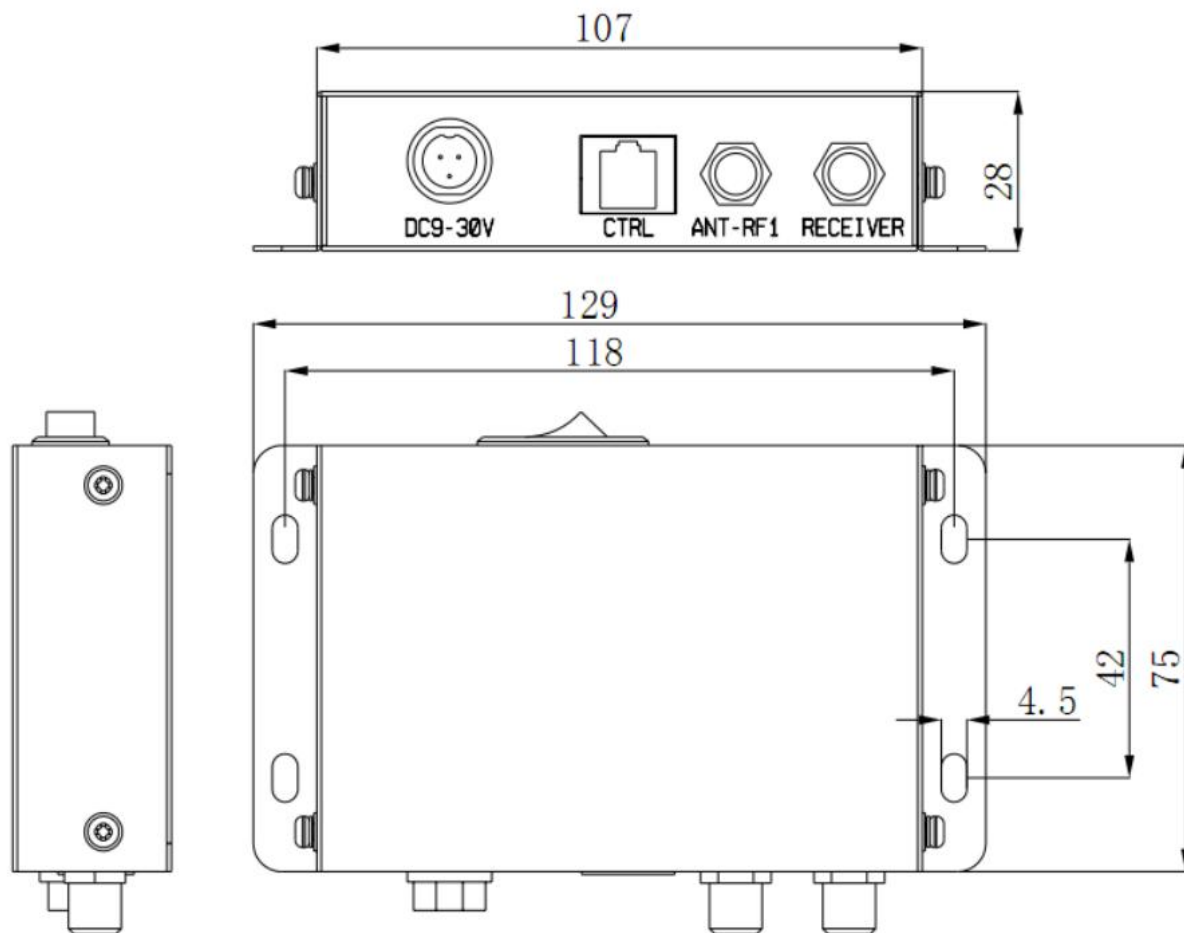

1. A dry secure location is required for the IDU to be mounted.
2. Drill the mounting holes prepare the site for installation.

## 2. Operation

---

---

This guide explains how to operate the IDU. The IDU is the system's user interface, providing access to the system and its functions through an LCD display

---

The antenna system is easy to use. Before you powering on IDU, Please double check follow step:

1. The antenna has a clear view of the sky
  2. All the cables are connected correctly
  3. Turn on your satellite TV **STB**(set top box) and TV
- 

### Start Screen



### HOME

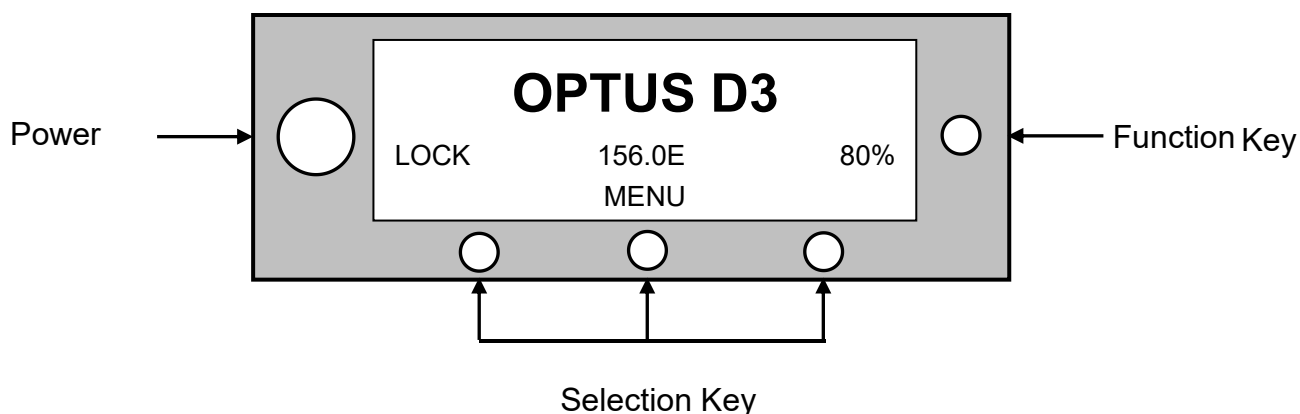



## 2.1 Change Target Satellite

---

---

You can manually change target satellite which you want to lock on among the preset satellite group by **Function** key.

 You must select a preset satellite group you want to lock on in “**SET SAT PAIRS**”. See next page.

---

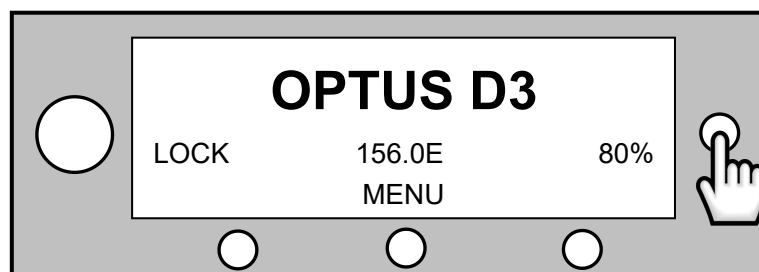

In the normal mode, press **FUNCTION** key will enter satellite selection mode.

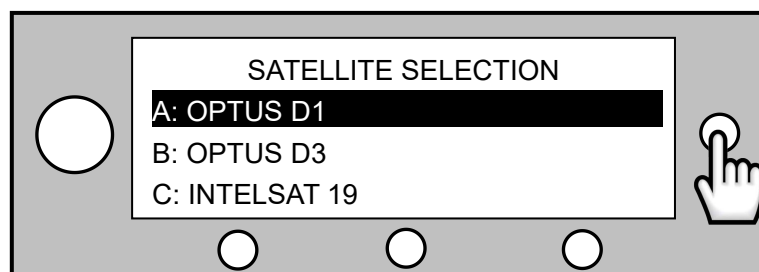

You can select the target satellite what you want in the list.

Wait for 3 second, the target satellite will be selected automatically and tracked by the antenna.

And it will return to **HOME** automatically at the same time.

## 2.2 Set Triple Satellite Pairs

---

Select a preset satellite group you want to lock on in the global satellite library. So that you can easily switch back or forth among them

---

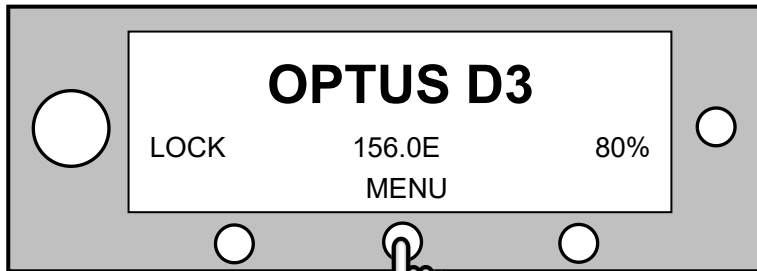

1. Press **MENU** will enter menu selection.

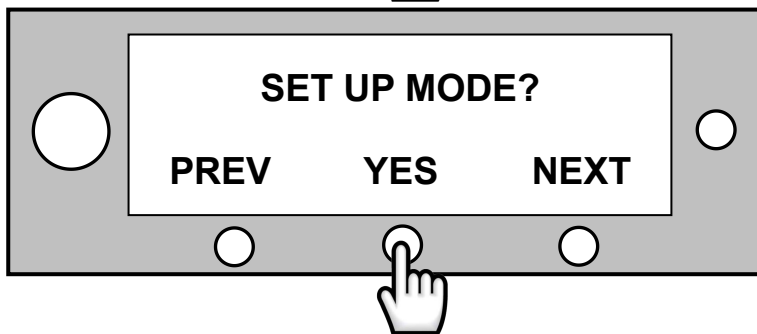

2. Press **YES** will enter **SET UP MODE**

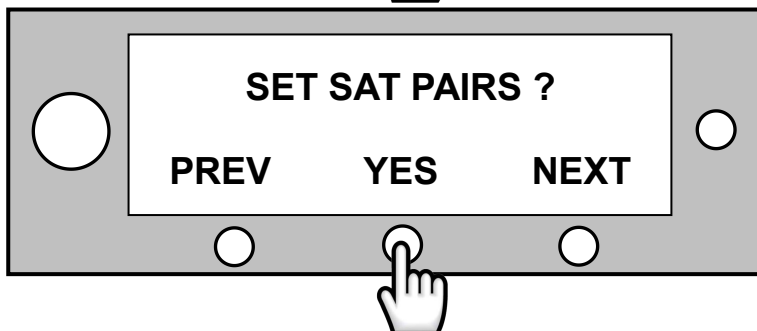

3. Press **YES** will enter **SET SAT PAIRS** mode

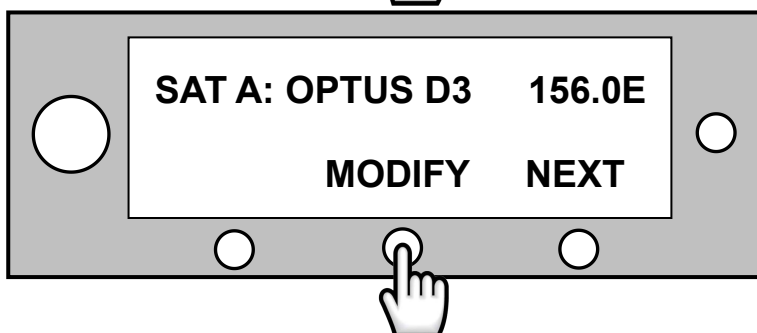

4. Press **MODIFY** will enter **SAT A** modify mode. Go to step5.  
Or press **NEXT** will enter **SAT B** . Go to step6  
Or press "**Function Key**" will go to step10

## 2.2 Set Triple Satellite Pairs

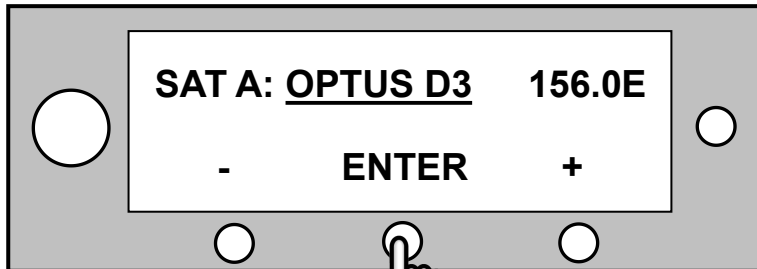

5. Press **+/-** to select the satellite.  
Or press **ENTER** will input the accept data.  
Go to step4

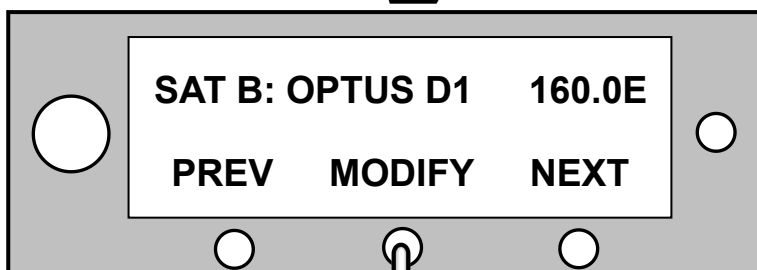

6. Press **MODIFY** will enter SAT B modify mode.  
Or press **NEXT** will enter **SAT C** modify mode.  
Go to step8

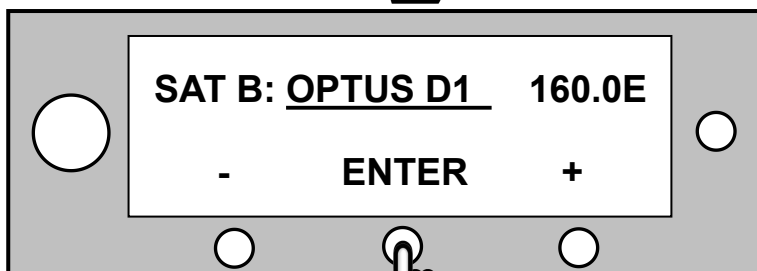

7. Press **+/-** to select the satellite.  
Or press **ENTER** will input the accept data.  
Go to step6

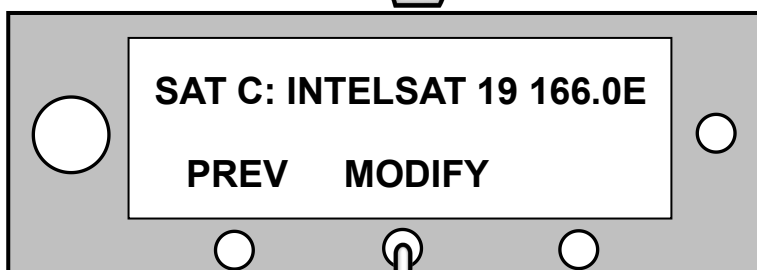

8. Press **MODIFY** to enter **SAT C** modify mode.  
Or press **NEXT** to go to step10  
If there is nothing have been modified, it will go to step3



9. Press **ENTER** will input the accept data. Then go to step8  
Or press **+/-** to change the satellite.

## 2.2 Set Triple Satellite Pairs

---

---

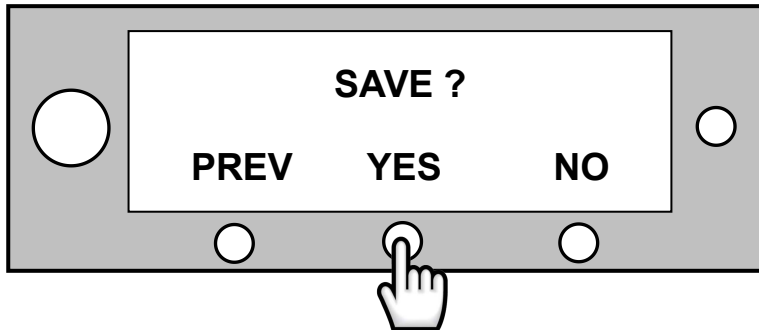

10. Press **PREV** will return to step 8  
Or press **YES** will save the setting  
Or press **NO** will cancel the setting

## 2.3 Set LNB Information

 Set up the LNB information is very important. The information of LNB must match with the LNB inside of the ODU. If not, the antenna may not lock onto the target satellite.

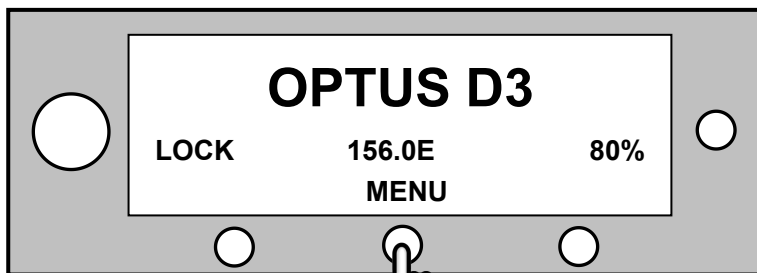

1. Press **MENU** will enter menu selection.

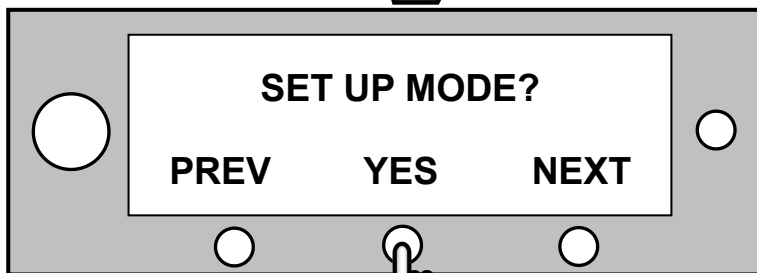

2. Press **YES** will enter **SET UP MODE**

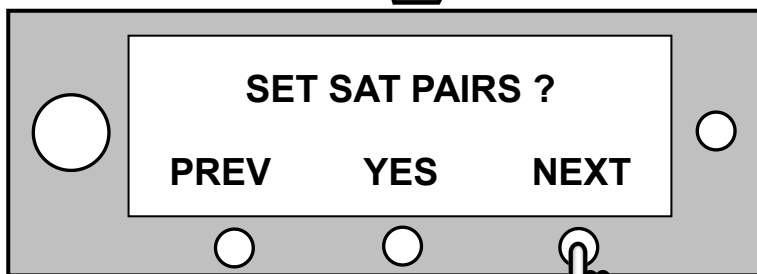

3. Press **NEXT** will go to next selection

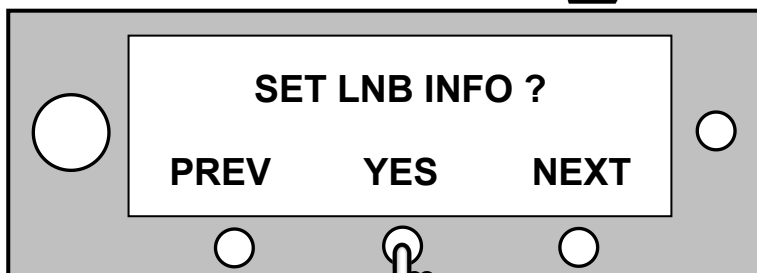

4. Press **YES** will enter "SET LNB INFO"

## 2.3 Set LNB Information

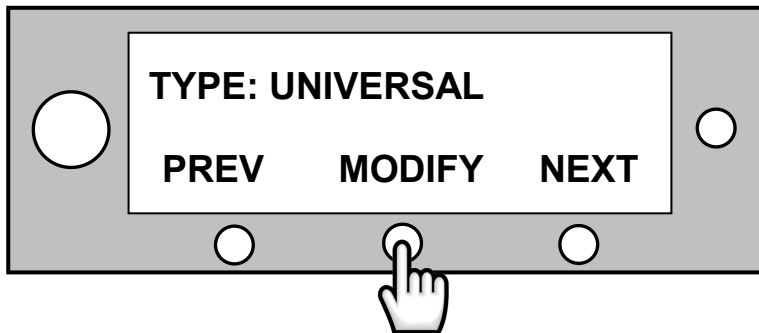

5. Press **MODIFY** will enter **LNB TYPE** modify mode.

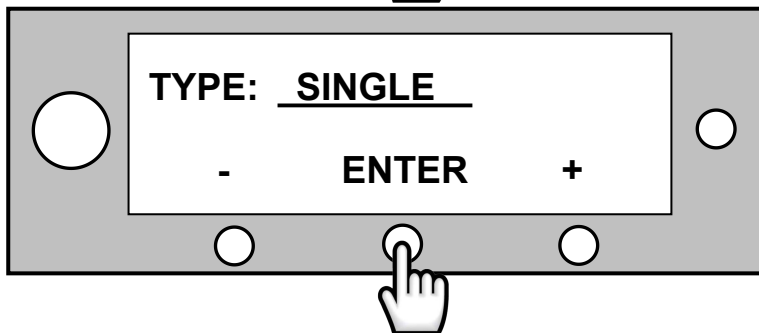

6. Press +/- to change LNB type  
Press **ENTER** will input the accept data. Go to step5

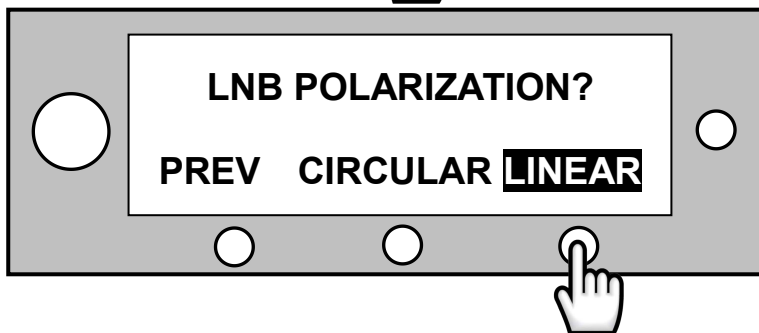

7. Select LNB Polarization

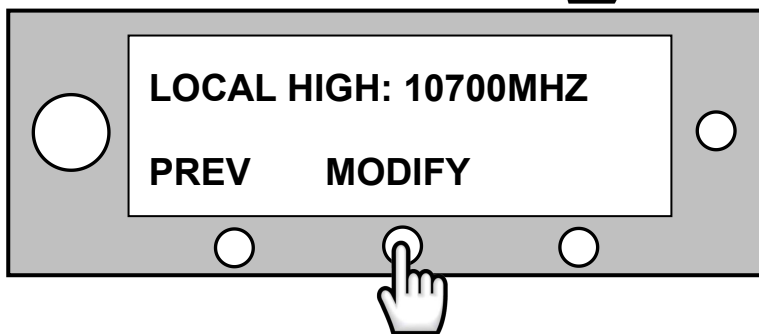

8. Press **MODIFY** will enter **HIGH LOCAL FREQUENCY** modify mode. The cursor will be flashing.  
Press **Function** key will go to step4 if there is nothing has been changed.  
Or it will go to step10

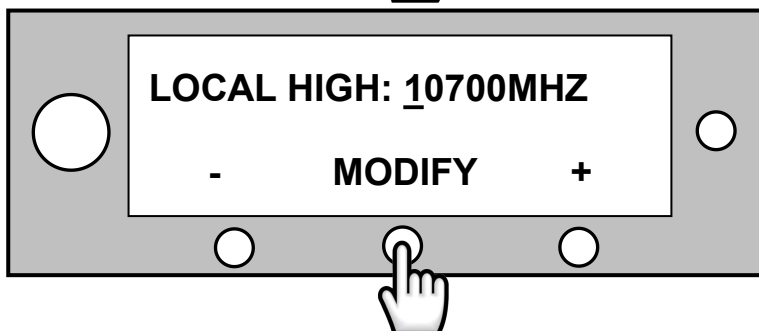

9. Press **MODIFY** the cursor will stop flashing.  
Or press +/- will move the cursor.  
Or press **Function** key will go to step8.

## 2.3 Set LNB Information

---

---

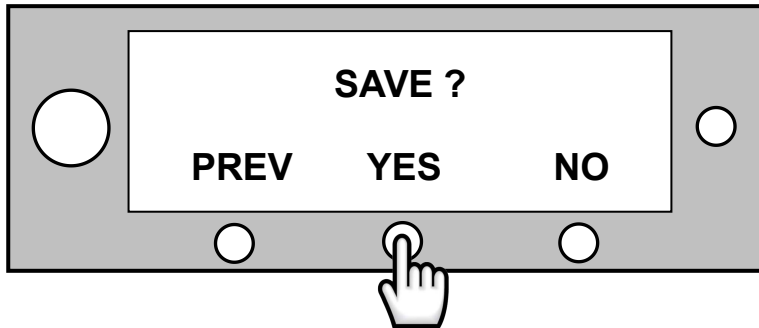

10. Press **PREV** will return to step 8  
Or press **YES** will save the setting  
Or press **NO** will cancel the setting

## 2.4 Set GPS Information

---

---

 Set up the local GPS information will help the antenna to lock onto the target satellite more quickly. Actually, GPS information is also effect to skew angle.

---

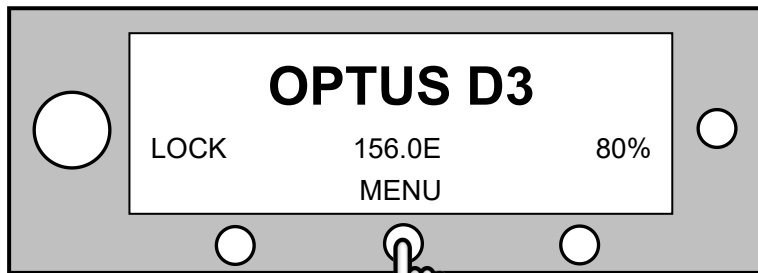

1. Press **MENU** will enter menu selection.

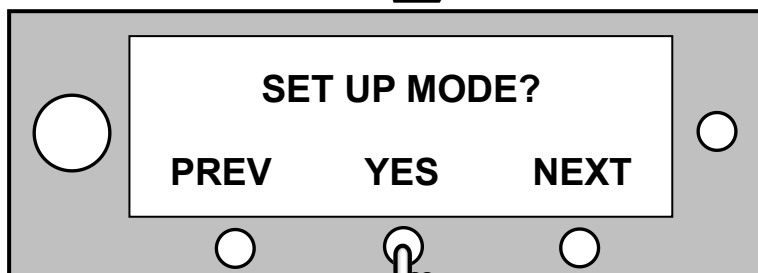

2. Press **MENU** will enter **SET UP MODE**.

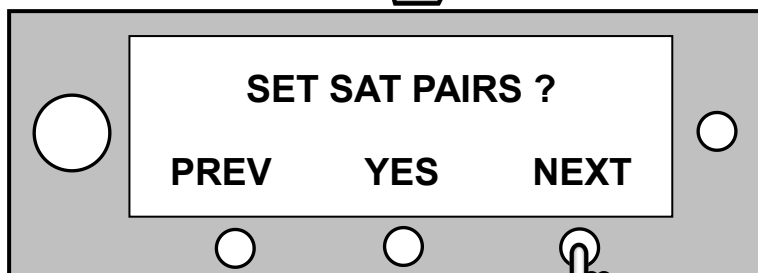

3. Press **NEXT** twice will go to **SET GPS INFO** selection.

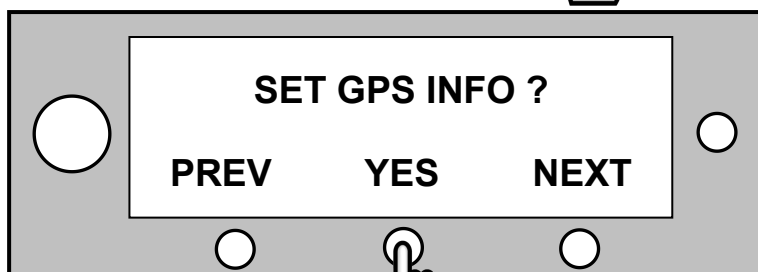

4. Press **YES** will enter **SET GPS INFO**.



## 2.4 Set GPS Information

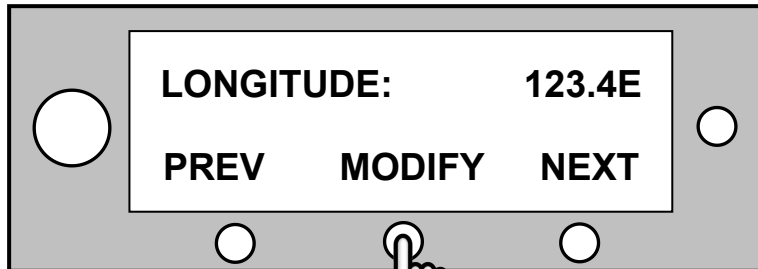

5. Press **MODIFY** will enter **LONGITUDE** modify mode. The cursor will be flashing. **OR** press **NEXT** will go to step8.

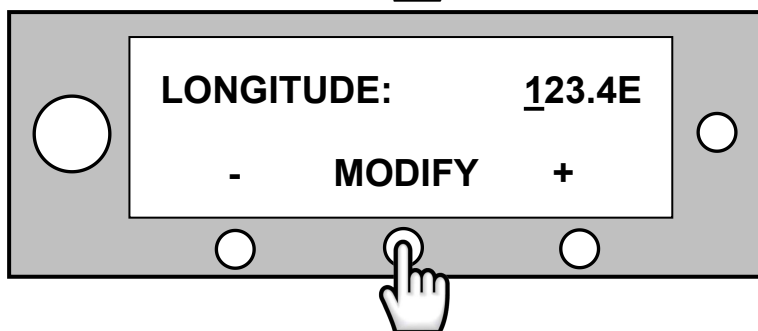

6. Press **MODIFY** the cursor will stop flashing. **OR** press +/- will move the cursor. **OR** press **Function** key will go to step5.

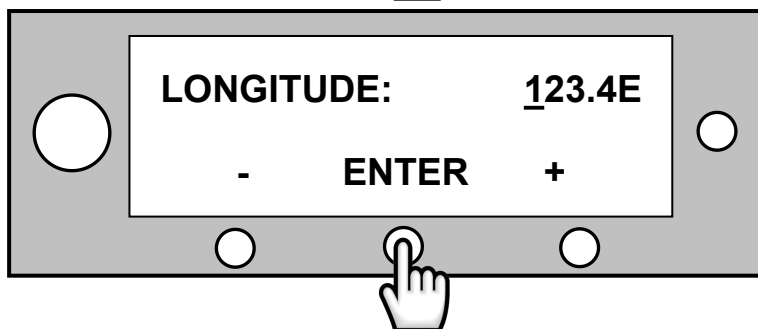

7. Press +/- will modify the bit of data where the cursor be flashing. **OR** press **ENTER** will input the accept data. And the cursor will stop flash. Go to step6

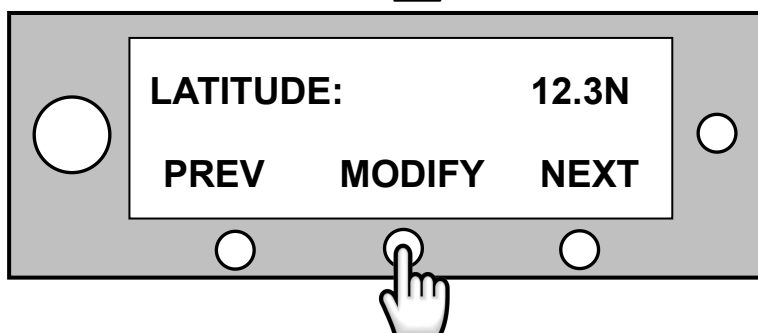

8. Press **MODIFY** will enter **LATTITUDE** modify mode. **OR** press **NEXT** will go to step11.

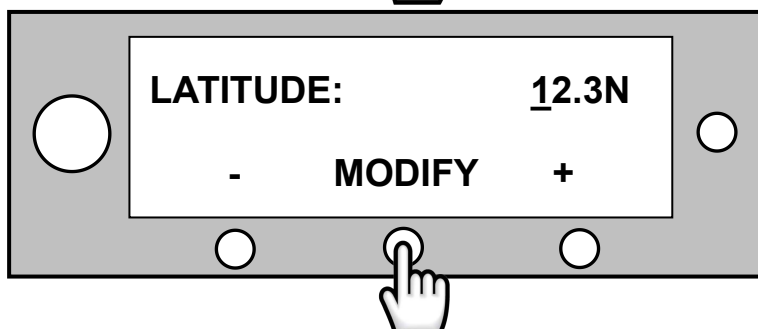

9. Press **MODIFY** the cursor will be flashing. **OR** press +/- will move the cursor. **OR** press **Function** key will go to step8.

## 2.4 Set GPS Information

---

---

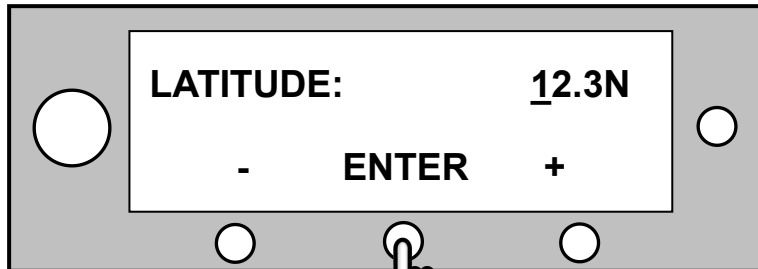

10. Press +/- will modify the bit of data where the cursor be.  
Or press **ENTER** will input the accept data. And the cursor will stop flashing. Go to step9

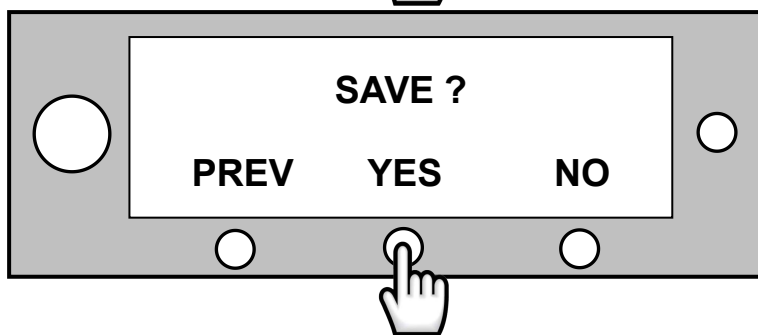

11. Press **PREV** will return to step8  
Or press **YES** will save the setting  
Or press **NO** will cancel the setting

## 2.5 Edit Satellite Information

---

System is built-in global satellite library. It's allowed to edit the satellite information according to the actual situation

 **Require only technician to edit the satellite information, otherwise antenna will probably not lock onto the target satellite**

---

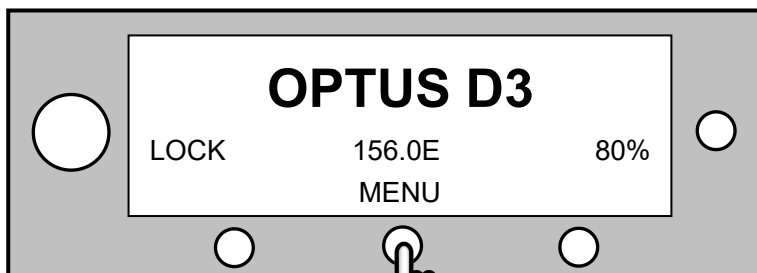

1. Press **MENU** will enter menu selection.

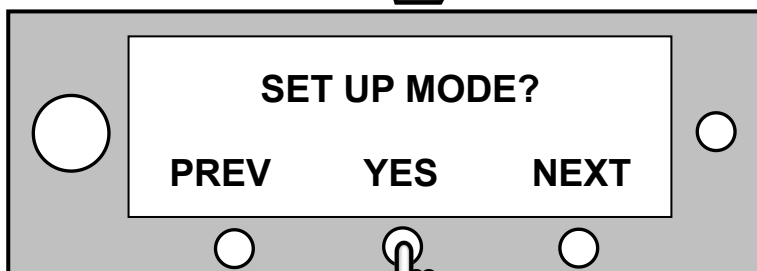

2. Press **YES** will enter **SET UP MODE**.

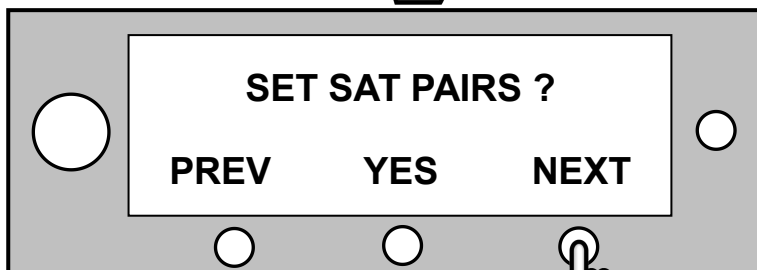

3. Press **NEXT** four times will go to **EDIT SAT INFO** selection

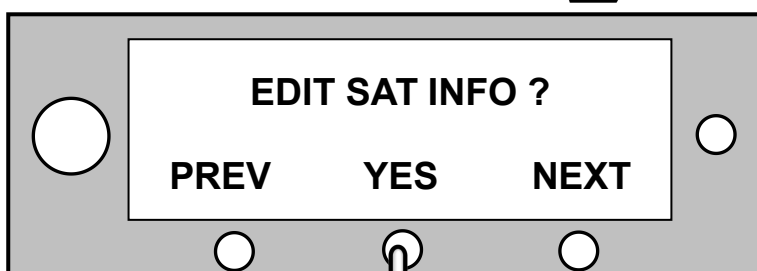

4. Press **YES** will enter **EDIT SAT INFO**

## 2.5 Edit Satellite Information

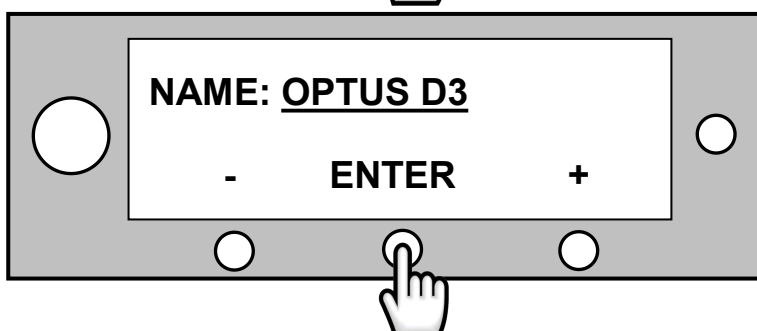
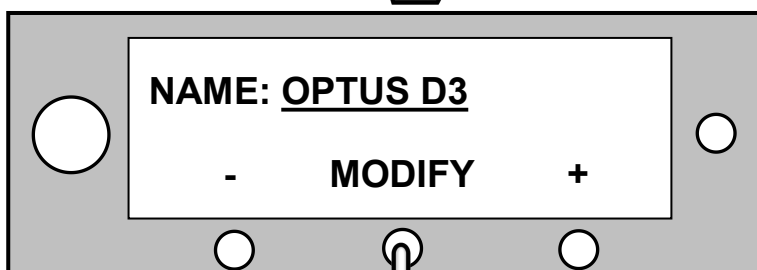
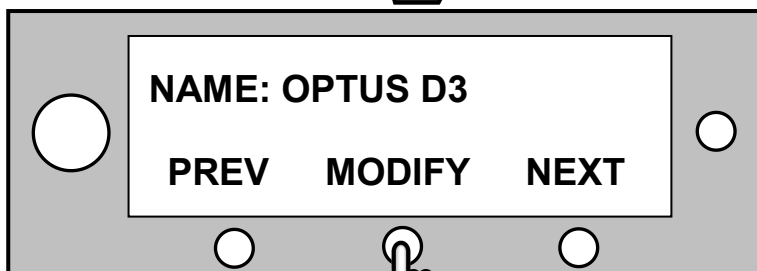
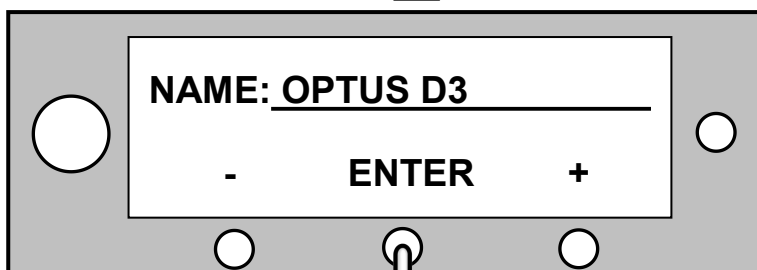
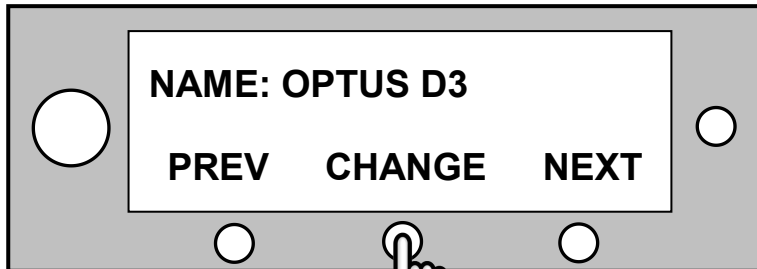

5. Press **CHANGE** can change another satellite.  
Go to step6  
Or press **NEXT** go to step7

6. Press +/- can select a satellite you want to modify from the global satellite library  
Or press **ENTER** will input the accept data.  
Go to step5

7. Press **MODIFY** can modify the satellite name. The cursor will be flashing. Go to step8  
Or press **NEXT** will go to step10

8. Press **MODIFY** the cursor will stop flashing. Go to step9  
Or press +/- will move the cursor.  
Or press **Function** key will go to step7.

9. Press +/- will modify the bit of data where the cursor be  
Or press **ENTER** will input the accept data.  
And the cursor will be flashing.  
Go to step8

## 2.5 Edit Satellite Information

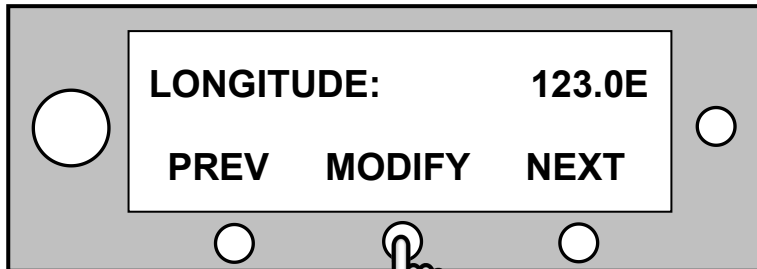

10. Press **MODIFY** can modify the satellite longitude. The cursor will be flashing. Press **NEXT** go to step13.

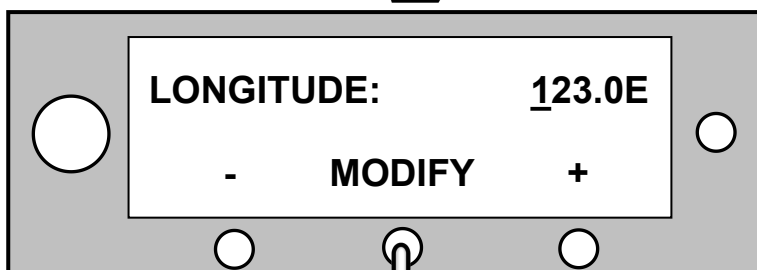

11. Press **MODIFY** the cursor will stop flashing. Or press **+/-** will move the cursor. Or press **Function** key will go to step10.

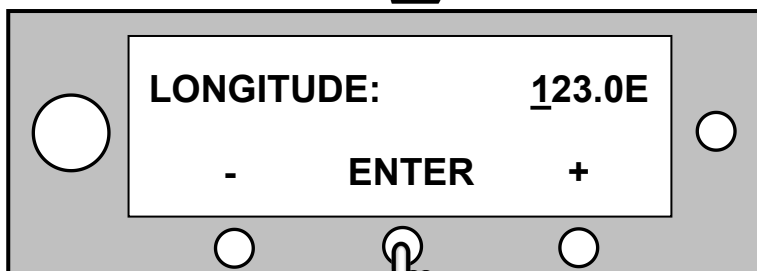

12. Press **+/-** will modify the bit of data where the cursor be. Or press **ENTER** will input the accept data. And the cursor will be flashing. Go to step11

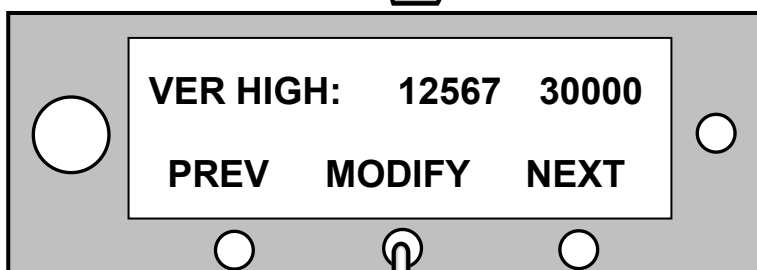

13. Press **MODIFY** can modify the **HIGH VERTICAL FREQUENCY** and **HIGH VERTICAL SYMBOLRATE**. Press **NEXT** go to step16. Press **PREV** go to step10.

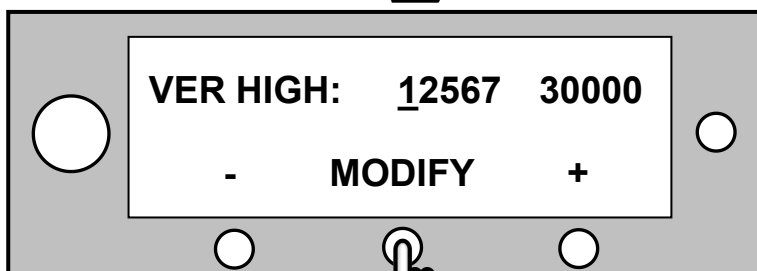

14. Press **MODIFY** the cursor will stop flashing. Or press **+/-** will move the cursor. Or press **Function** key will go to step13.

## 2.5 Edit Satellite Information

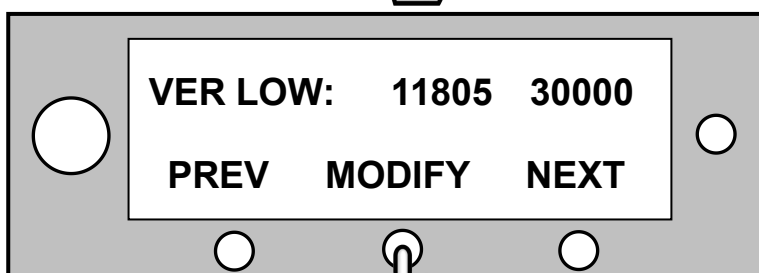
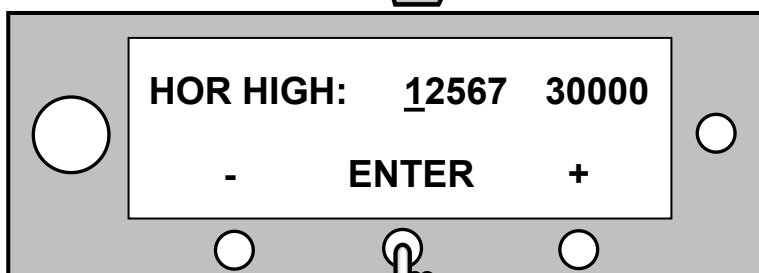
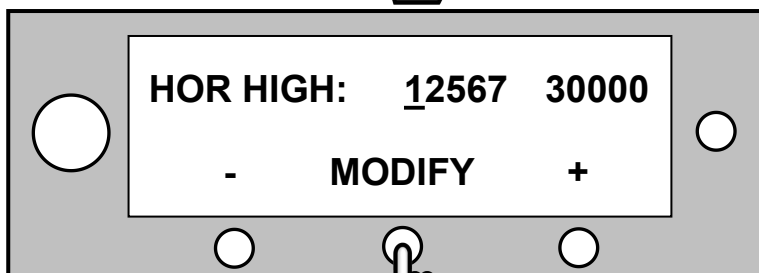
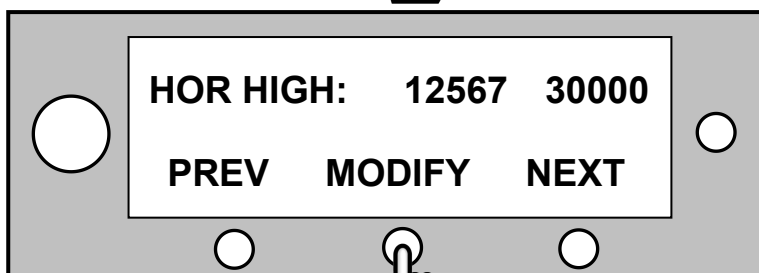

15. Press +/- will modify the bit of data where the cursor be.

Or press **ENTER** will input the accept data.

And the cursor will be flashing. Go to step 14

16. Press **MODIFY** can modify the **HIGH HORIZONTAL FREQUENCY** and **HIGH HORIZONTAL SYMBOLRATE**. The cursor will be flashing.

Press **NEXT** go to step 19.

Press **PREV** go to step 13.

17. Press **MODIFY** the cursor will stop flashing.

Or press +/- will move the cursor.

Or press **Function** key will go to step 16.

18. Press +/- will modify the bit of data where the cursor be.

Or press **ENTER** will input the accept data.

And the cursor will be flashing. Go to step 17

19. Press **MODIFY** can modify the **LOW VERTICAL FREQUENCY** and **LOW VERTICAL SYMBOLRATE**. The cursor will be flashing.

Press **NEXT** go to step 22.

Press **PREV** go to step 16.

## 2.5 Edit Satellite Information

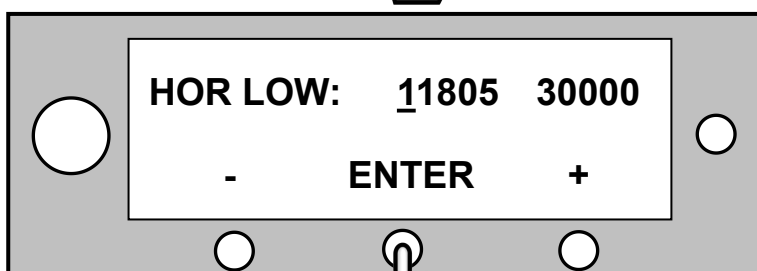
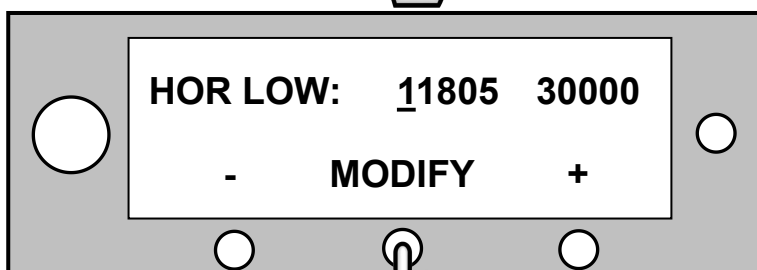
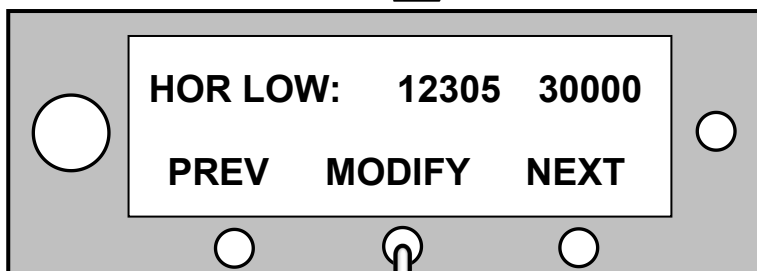
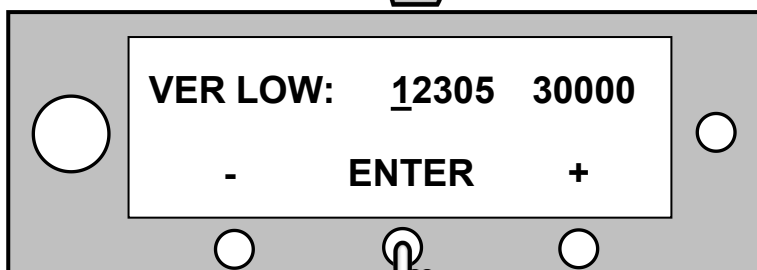
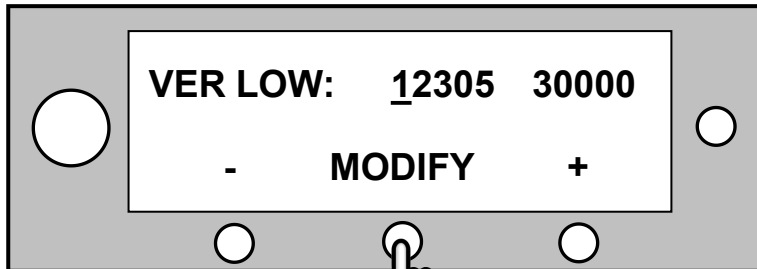

20. Press **MODIFY** the cursor will stop flashing.  
Or press +/- will move the cursor.  
Or press **Function** key will go to step19.

21. Press +/- will modify the bit of data where the cursor be.  
Or press **ENTER** will input the accept data.  
And the cursor will be flashing.Go to step20

22. Press **MODIFY** can modify the **LOW HORIZONTAL FREQUENCY** and **LOW HORIZONTAL SYMBOLRATE**. The cursor will be flashing.  
Press **NEXT** go to step25.  
Press **PREV** go to step19.

23. Press **MODIFY** the cursor will be flashing.  
Or press +/- will move the cursor.  
Or press **Function** key will go to step22.

24. Press +/- will modify the bit of data where the cursor stop flash.  
Or press **ENTER** will input The accept data. And the cursor will be flashing.Go to step2

## 2.5 Edit Satellite Information

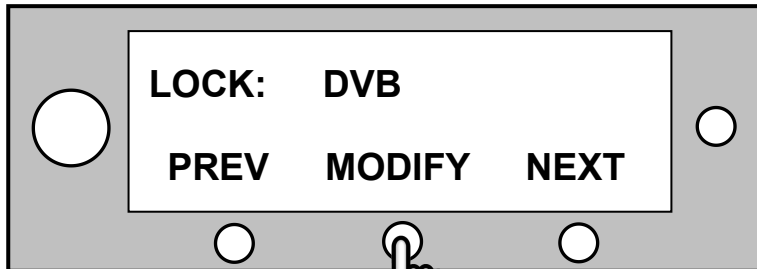

25. Press **MODIFY** can modify the demodulate lock mode Press **PREV** go to step22. Press **NEXT** go to step27.(**AGC**) Go to step30(**DVB**)



26. Press +/- will modify the data(DVB AGC ABS) Or press **ENTER** will input the accept data. Go to step25

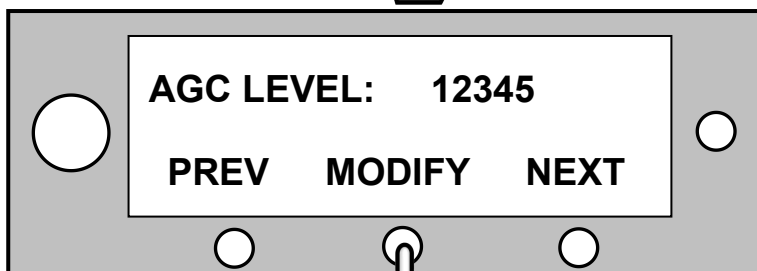

27. Press **MODIFY** can modify the **AGC SIGNAL LEVEL**.The cursor will be flashing. Press **NEXT** go to step30. Press **PREV** go to step25.

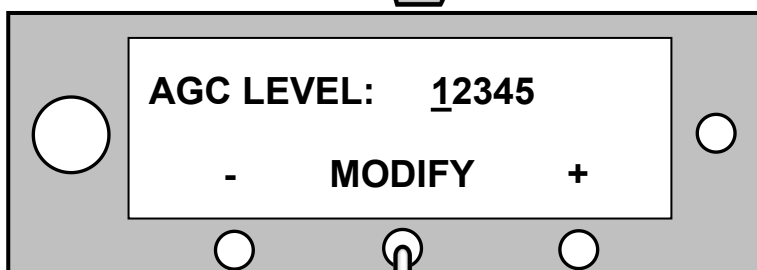

28. Press **MODIFY** the cursor will stop flashing. Or press +/- will move the cursor. Or press **Function** key will go to step27.

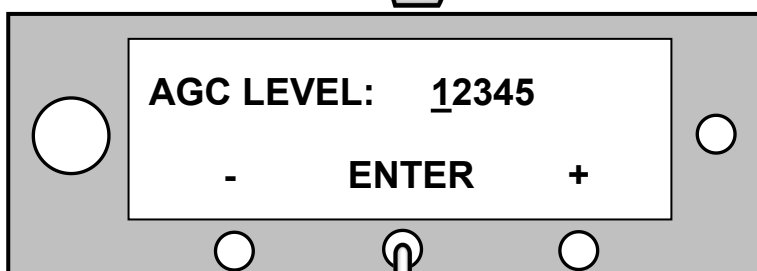

29. Press +/- will modify the bit of data where the cursor stop flash. Or press **ENTER** will input The accept data. And the cursor will be flashing.Go tostep28



## 2.5 Edit Satellite Information

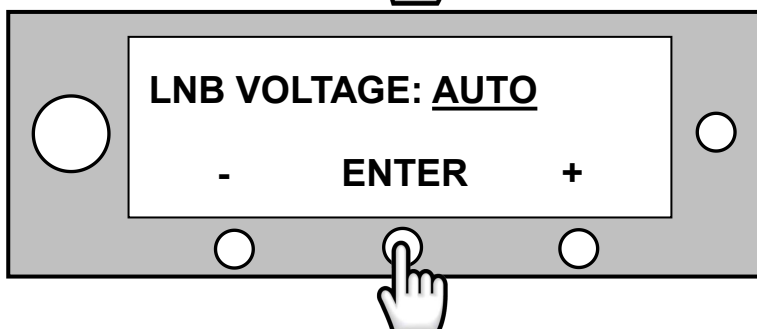
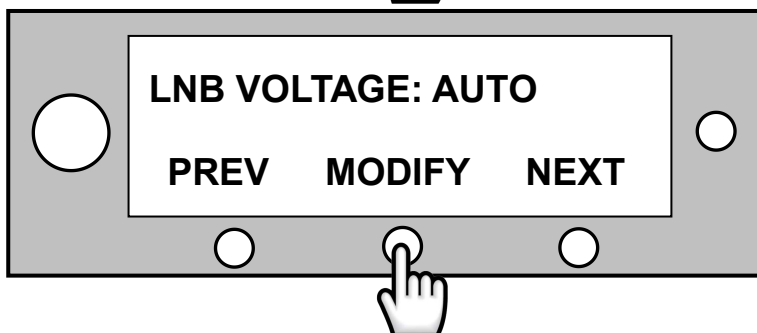
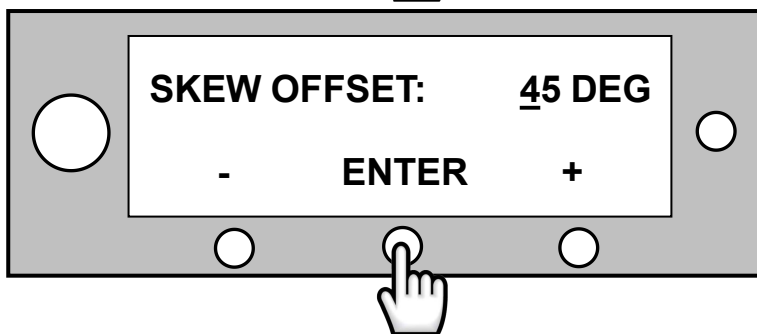
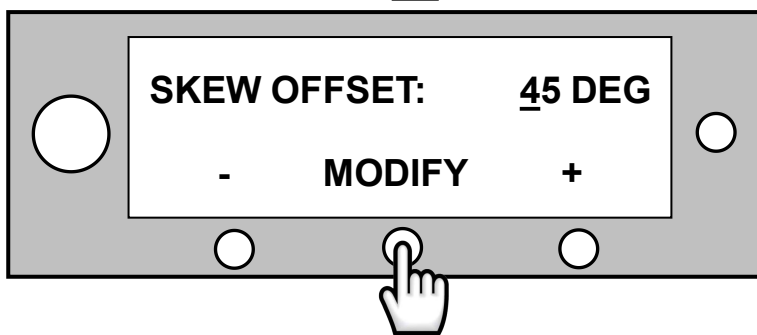
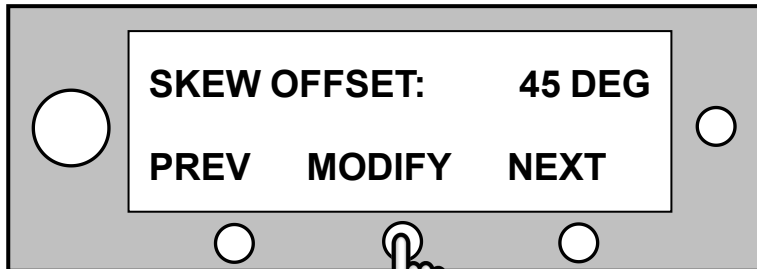

30. Press **MODIFY** can modify the **SKEW OFFSET**  
Press **NEXT** go to step33.  
Press **PREV** go to step27.

31. Press **MODIFY** the cursor will stop flashing.  
Or press **+/-** will move the cursor.  
Or press **Function** key will go to step30.

32. Press **+/-** will modify the bit of data where the cursor stop flash.  
**OR** press **ENTER** will input the accept data.  
And the cursor will be flashing.Go to step31

33. Press **MODIFY** can modify the **LNB'S VOLTAGE CONTROL MODE**  
Press **NEXT** go to step35.  
Press **PREV** go to step30.

34. Press **+/-** will modify the data (AUTO,13V,18V)  
Or press **ENTER** will input the accept data.  
Go to step33

## 2.5 Edit Satellite Information

---

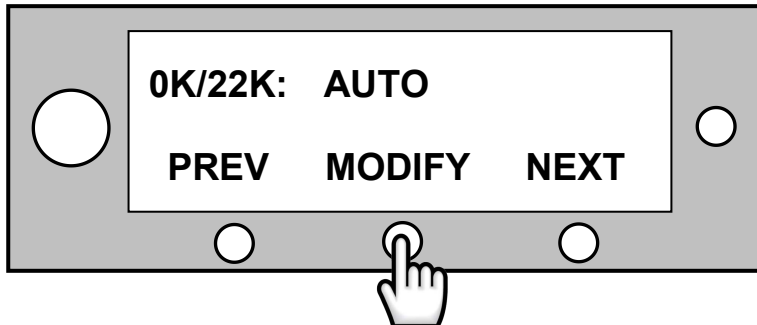

35. Press **MODIFY** can modify the **0K/22K CONTROL MODE**.  
Press **NEXT** go to step37.  
Press **PREV** go to step33.

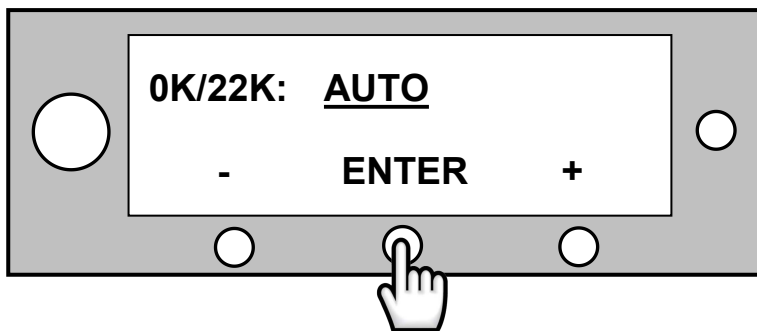

36. Press +/- will modify the data (AUTO,0K,22K)  
Or press **ENTER** will input the accept data. Go to step35

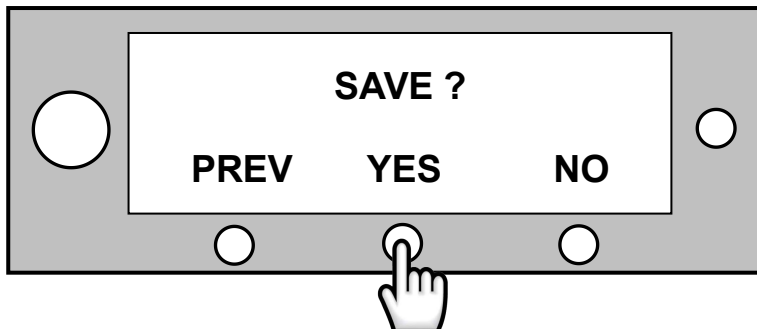

37. Press **YES** save all the modified data  
Press **NO** cancel the modified data.  
Press **PREV** go to step35

## 2.6 Set To Default Settings

---

---

 This action will set to factory default settings. So you must confirm before you do

---

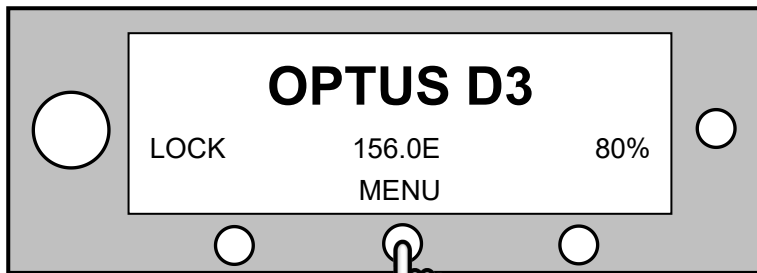

1. Press **MENU** will enter menu selection.

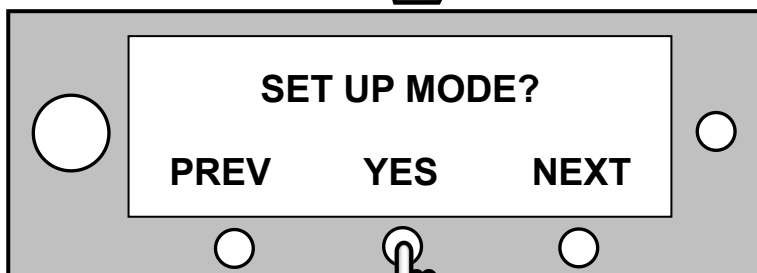

2. Press **YES** will enter **SET UP MODE**.

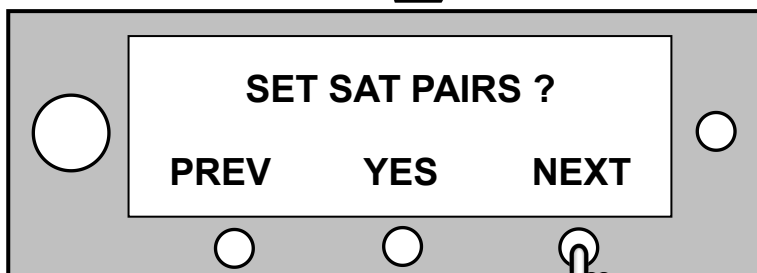

3. Press **NEXT** five times will go to **SET TO DEFAULT** selection

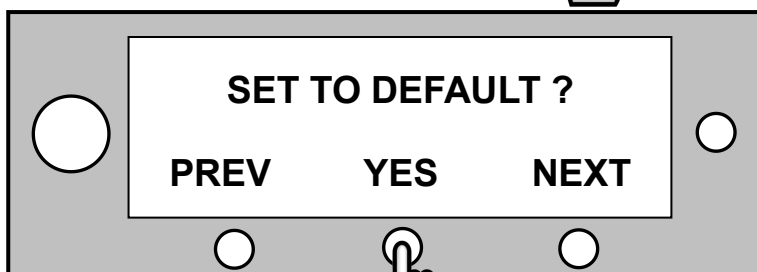

4. Press **YES** will enter **SET TO DEFAULT**

## 2.6 Set To Default Settings

---

---

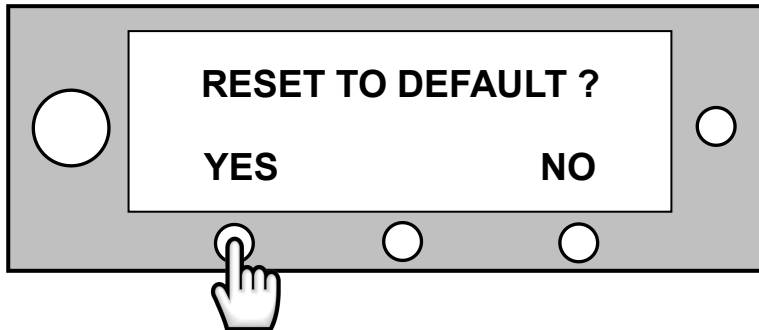

5. Press **YES** will set all the data to default setting  
Press **NO** cancel the operate.

## 2.7 Monitor and Diagnostic

---

You can monitor the real-time data of the system. IDU will tell you whether the relevant data working properly or not. At the same time, It will give you some suggestions to fix it if it is faulty.

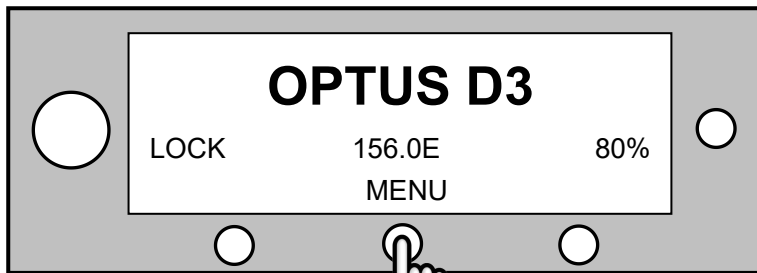

1. Press **MENU** will enter menu selection.

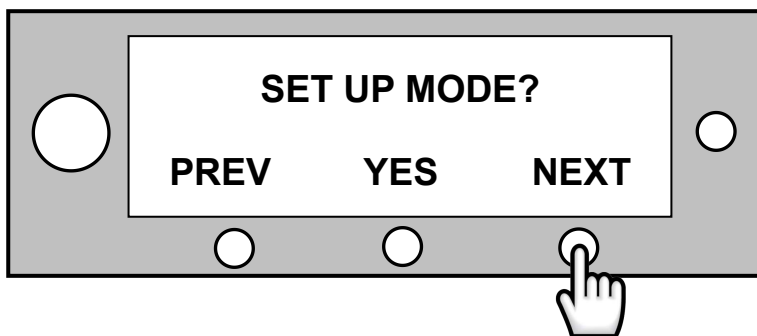

2. Press **NEXT** go to **MONITOR/DIAGNOSTIC** selection

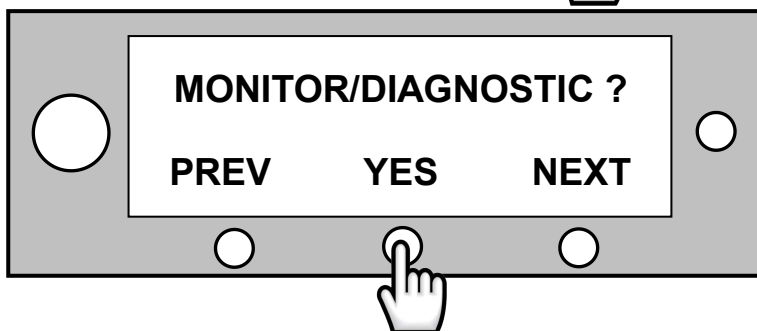

3. Press **YES** will enter **MONITOR/DIAGNOSTIC** mode

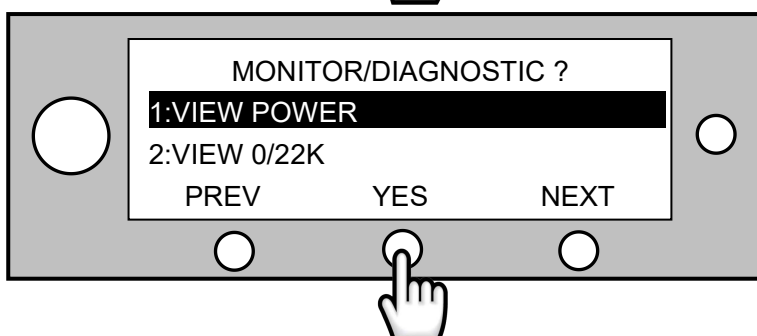

## 2.7 Monitor and Diagnostic

---



---

Monitor/Diagnostic selection		
1	VIEW POWER	Power of whole system, include IDU/ODU/LNB/STB
2	VIEW 0/22K	0/22K. Only relate to universal LNB
3	VIEW LIMIT	Limit switch of ODU
4	VIEW GPS	GPS information
5	VIEW SAT SIGNAL	Satellite signal
6	EL MOVE STEP	Manual control mode
7	AZ MOVE STEP	
8	SKEW MOVE STEP	
9	COMMUNICATION	State of communication (IDU-ODU , GPS)
10	SOFTWARE VERSION	Software version
11	SELF DIAGNOSIS	State of whole system,include IDU and ODU

## 2.7.1 Manual control mode

---

 This feature is very useful for you to control the angle of the antenna manually, include EL, AZ, SKEW.

---

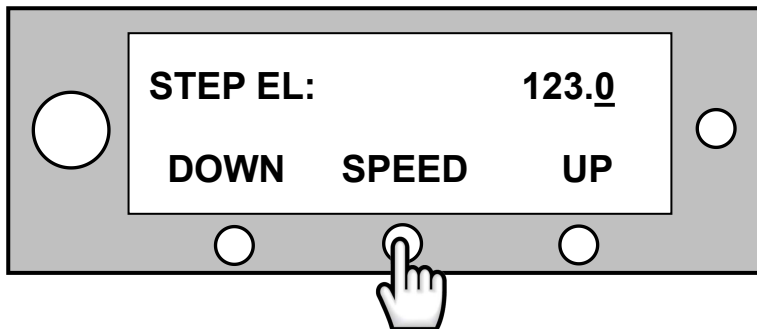

**UP/DOWN:**The direction of rotation

**SPEED:**The speed of rotation

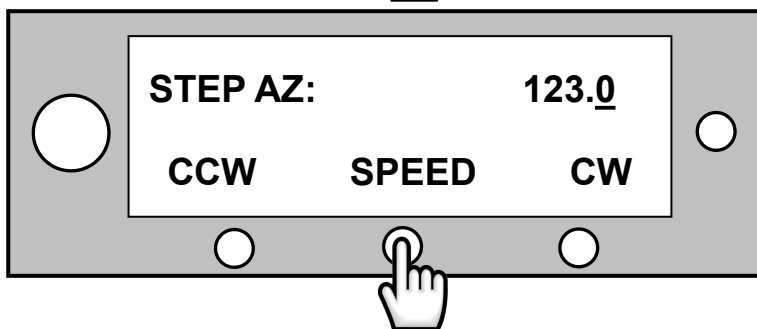

**CW/CCW:**The direction of rotation

**SPEED:**The speed of rotation

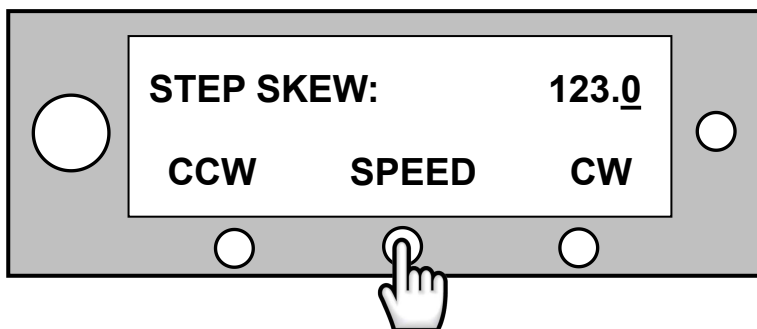

**CW/CCW:**The direction of rotation

**SPEED:**The speed of rotation

## 2.7.2 Self-diagnosis

---

---

When you need any technical support, please send a photo of menu option 11 as shown below, so we can work out what's wrong and provide the corresponding solutions.

---

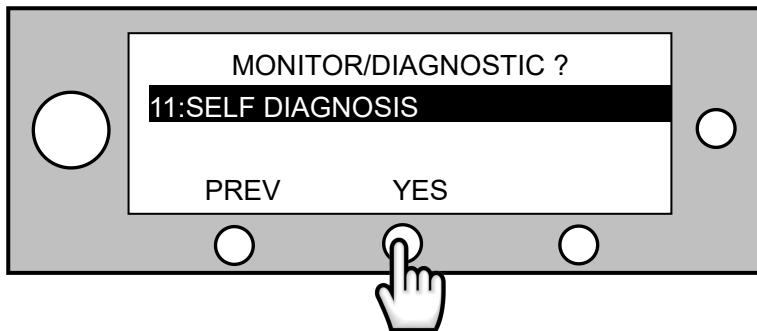

1. Press **YES** will enter self-diagnosis.

